



HiPerFRED

$V_{RRM} = 600\text{ V}$
 $I_{FAV} = 6\text{ A}$
 $t_{rr} = 20\text{ ns}$

High Performance Fast Recovery Diode
 Low Loss and Soft Recovery
 Single Diode

Part number

DSEP6-06AS

Marking on Product: 6P060AS

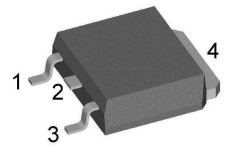

Backside: cathode

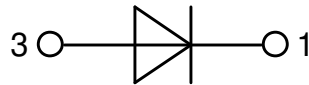

Features / Advantages:

- Planar passivated chips
- Very low leakage current
- Very short recovery time
- Improved thermal behaviour
- Very low I_{rm}-values
- Very soft recovery behaviour
- Avalanche voltage rated for reliable operation
- Soft reverse recovery for low EMI/RFI
- Low I_{rm} reduces:
 - Power dissipation within the diode
 - Turn-on loss in the commutating switch

Applications:

- Antiparallel diode for high frequency switching devices
- Antisaturation diode
- Snubber diode
- Free wheeling diode
- Rectifiers in switch mode power supplies (SMPS)
- Uninterruptible power supplies (UPS)

Package: TO-252 (DPak)

- Industry standard outline
- RoHS compliant
- Epoxy meets UL 94V-0

Disclaimer Notice

Information furnished is believed to be accurate and reliable. However, users should independently evaluate the suitability of and test each product selected for their own applications. Littelfuse products are not designed for, and may not be used in, all applications. Read complete Disclaimer Notice at www.littelfuse.com/disclaimer-electronics.



Fast Diode				Ratings			
Symbol	Definition	Conditions	min.	typ.	max.	Unit	
V_{RSM}	max. non-repetitive reverse blocking voltage				600	V	
V_{RRM}	max. repetitive reverse blocking voltage				600	V	
I_R	reverse current, drain current	$V_R = 600\text{ V}$			50	μA	
		$V_R = 600\text{ V}$			0.2	mA	
V_F	forward voltage drop	$I_F = 6\text{ A}$			2.03	V	
		$I_F = 12\text{ A}$			2.22	V	
		$I_F = 6\text{ A}$			1.34	V	
		$I_F = 12\text{ A}$			1.55	V	
I_{FAV}	average forward current	$T_C = 150^\circ\text{C}$			6	A	
		rectangular $d = 0.5$					
V_{FO}	threshold voltage	} for power loss calculation only			1.00	V	
r_F	slope resistance				34	m Ω	
R_{thJC}	thermal resistance junction to case				2.8	K/W	
R_{thCH}	thermal resistance case to heatsink			0.50		K/W	
P_{tot}	total power dissipation				55	W	
I_{FSM}	max. forward surge current	$t = 10\text{ ms}; (50\text{ Hz}), \text{ sine}; V_R = 0\text{ V}$			40	A	
C_J	junction capacitance	$V_R = 400\text{ V}$ $f = 1\text{ MHz}$			5	pF	
I_{RM}	max. reverse recovery current	} $I_F = 6\text{ A}; V_R = 300\text{ V}$			3	A	
					5	A	
t_{rr}	reverse recovery time	} $-di_F/dt = 200\text{ A}/\mu\text{s}$			20	ns	
					80	ns	



Package TO-252 (DPak)			Ratings			
Symbol	Definition	Conditions	min.	typ.	max.	Unit
I_{RMS}	RMS current	per terminal			20	A
T_{VJ}	virtual junction temperature		-55		175	°C
T_{op}	operation temperature		-55		150	°C
T_{stg}	storage temperature		-55		150	°C
Weight				0.3		g
F_C	mounting force with clip		20		60	N

Product Marking



Ordering	Ordering Number	Marking on Product	Delivery Mode	Quantity	Code No.
Standard	DSEP6-06AS-TRL	6P060AS	Tape & Reel	2500	509806
Alternative	DSEP6-06AS-TUB	6P060AS	Tube	70	524993

Similar Part	Package	Voltage class
DSEP6-06BS	TO-252AA (DPak)	600

Equivalent Circuits for Simulation

** on die level*

$T_{VJ} = 175\text{°C}$

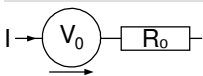

Fast Diode

$V_{0\ max}$	threshold voltage	1	V
$R_{0\ max}$	slope resistance *	30	mΩ



Outlines TO-252 (DPak)

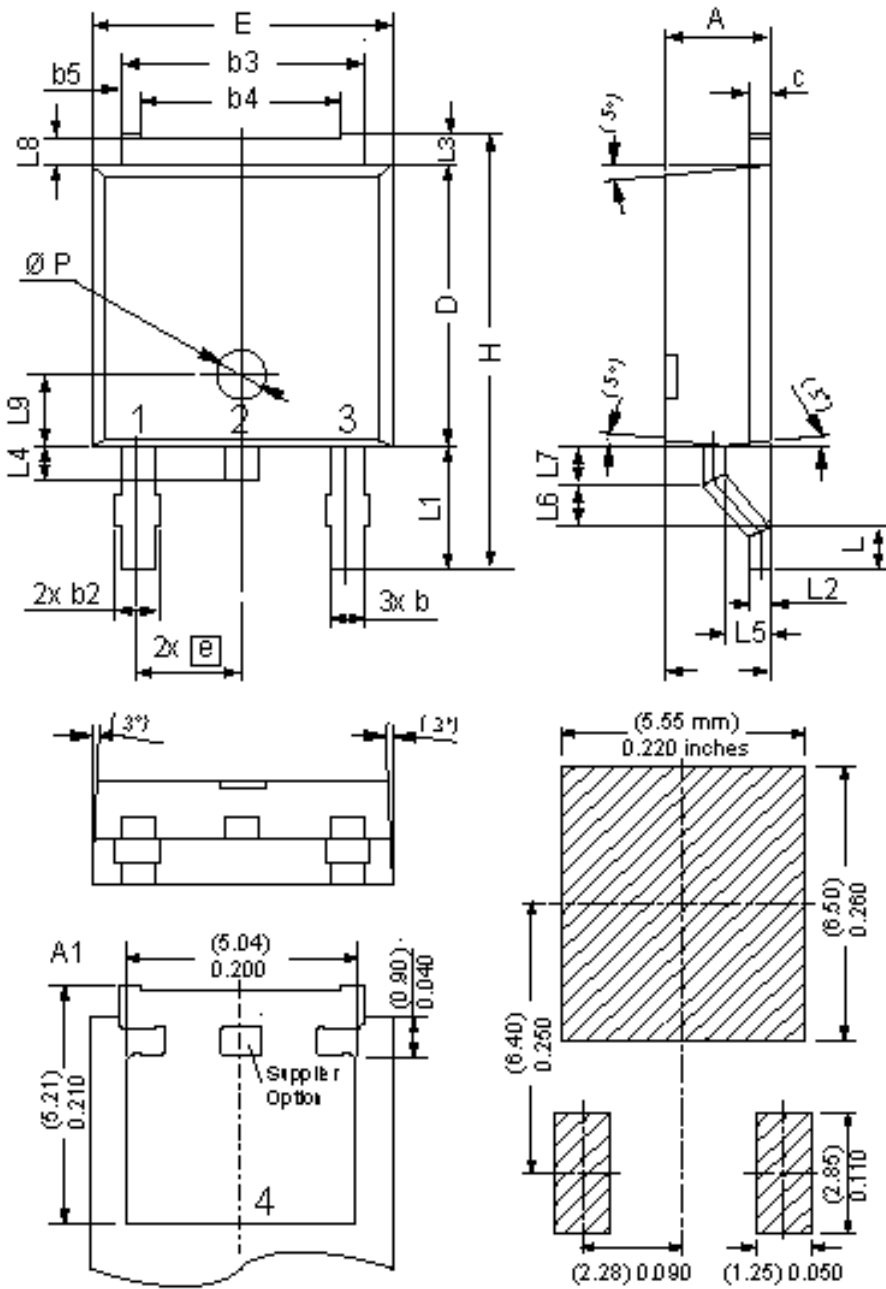

Dim	Millimeters		Inches	
	min	max	min	max
A	2.20	2.40	0.087	0.094
A1	2.10	2.50	0.083	0.098
b	0.66	0.86	0.026	0.034
b2	-	0.96	-	0.038
b3	5.04	5.64	0.198	0.222
b4	4.34	BSC	0.171	BSC
b5	0.50	BSC	0.020	BSC
c	0.40	0.86	0.016	0.034
D	5.90	6.30	0.232	0.248
E	6.40	6.80	0.252	0.268
e	2.10	2.50	0.083	0.098
H	9.20	10.10	0.362	0.398
L	0.55	1.28	0.022	0.050
L1	2.50	2.90	0.098	0.114
L2	0.40	0.60	0.016	0.024
L3	0.50	0.90	0.020	0.035
L4	0.60	1.00	0.024	0.039
L5	0.82	1.22	0.032	0.048
L6	0.79	0.99	0.031	0.039
L7	0.81	1.01	0.032	0.040
L8	0.40	0.80	0.016	0.031
L9	1.50	BSC	0.059	BSC
Ø P	1.00	BSC	0.039	BSC

Recommended min. footprint

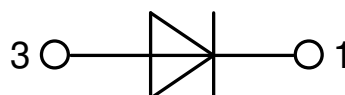

Fast Diode

 Fig. 1 Forward current I_F versus V_F

 Fig. 2 Typ. reverse recov. charge Q_r versus $-di_F/dt$

 Fig. 3 Typ. peak reverse current I_{RM} versus $-di_F/dt$

 Fig. 4 Typ. dynamic parameters Q_r , I_{RM} versus T_{VJ}

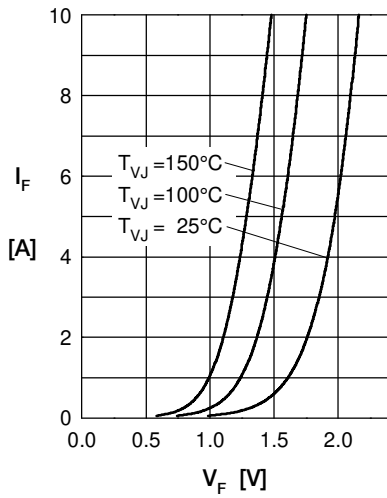
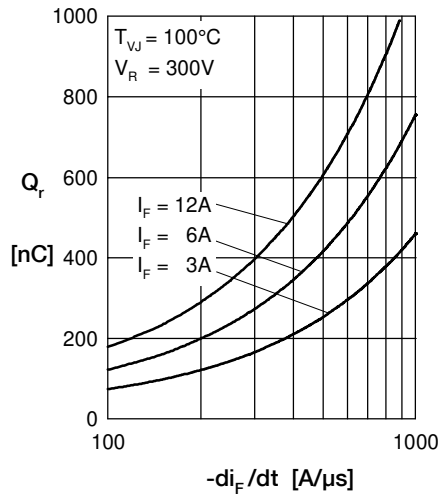
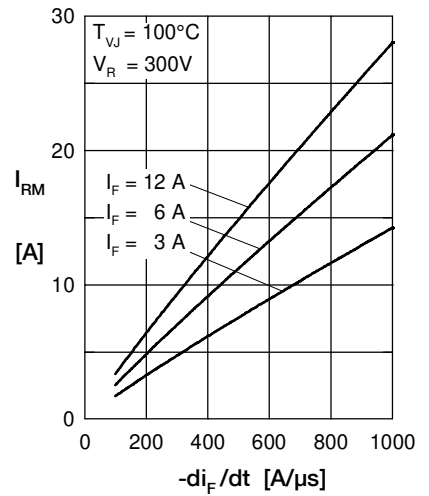
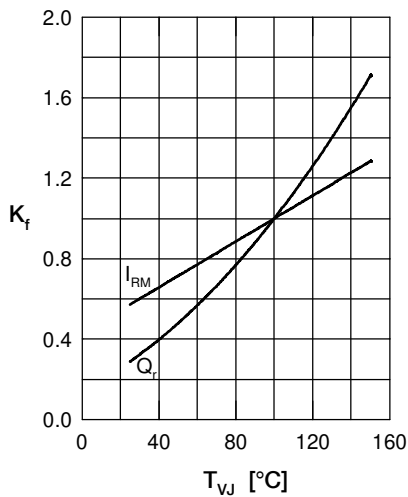
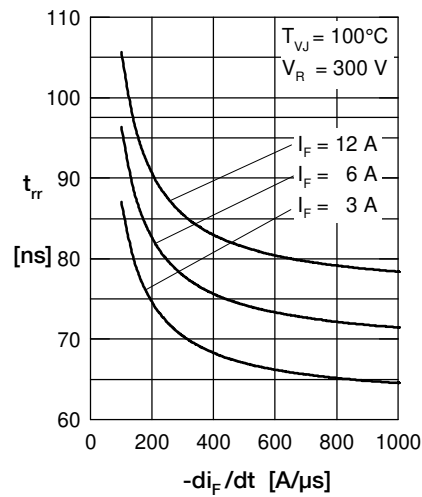
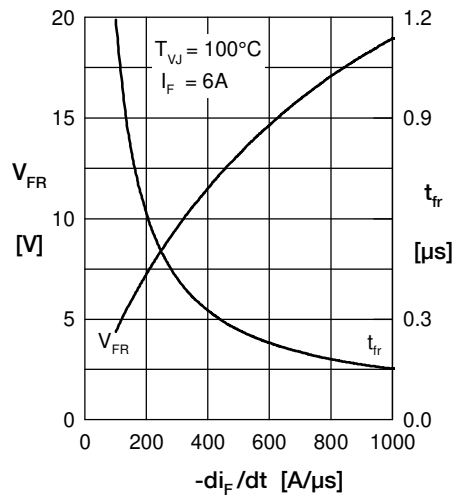
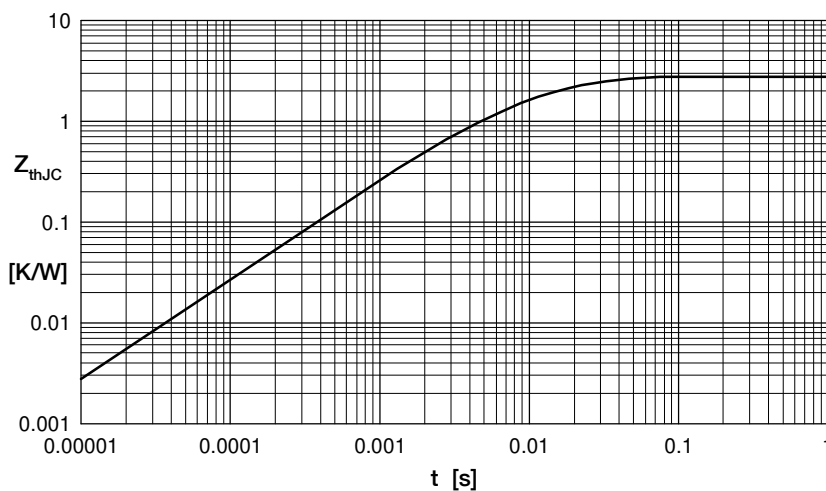
 Fig. 5 Recovery time t_{rr} versus $-di_F/dt$

 Fig. 6 Typ. peak forward voltage V_{FR} and t_{fr} versus di_F/dt

Fig. 7 Transient thermal resistance junction to case