

Standard Rectifier Module

| | |
|-------------------------|----------|
| 1~ Rectifier | |
| V_{RRM} | = 1800 V |
| I_{DAV} | = 18 A |
| I_{FSM} | = 550 A |

1~ Rectifier Bridge

Part number

VBO36-18NO8

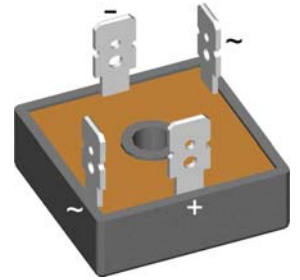

 E72873

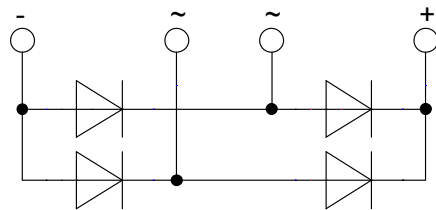

Features / Advantages:

- Planar passivated chips
- Very low leakage current
- Very low forward voltage drop
- Improved thermal behaviour

Applications:

- Diode for main rectification
- For one phase bridge configurations
- Supplies for DC power equipment
- Input rectifiers for PWM inverter
- Battery DC power supplies
- Field supply for DC motors

Package: FO-B

- Industry standard outline
- RoHS compliant
- ¼" fast-on terminals
- Easy to mount with one screw

| Rectifier | | | | Ratings | | |
|------------|--|---|-------------------------|---------|------|-------------------|
| Symbol | Definition | Conditions | min. | typ. | max. | Unit |
| V_{RSM} | max. non-repetitive reverse blocking voltage | $T_{VJ} = 25^{\circ}C$ | | | 1900 | V |
| V_{RRM} | max. repetitive reverse blocking voltage | $T_{VJ} = 25^{\circ}C$ | | | 1800 | V |
| I_R | reverse current | $V_R = 1800 V$ | $T_{VJ} = 25^{\circ}C$ | | 40 | μA |
| | | $V_R = 1800 V$ | $T_{VJ} = 150^{\circ}C$ | | 1.5 | mA |
| V_F | forward voltage drop | $I_F = 15 A$ | $T_{VJ} = 25^{\circ}C$ | | 1.04 | V |
| | | $I_F = 30 A$ | | | 1.14 | V |
| | | $I_F = 15 A$ | $T_{VJ} = 125^{\circ}C$ | | 0.93 | V |
| | | $I_F = 30 A$ | | | 1.06 | V |
| I_{DAV} | bridge output current | $T_C = 85^{\circ}C$ rectangular $d = 0.5$ | $T_{VJ} = 150^{\circ}C$ | | 18 | A |
| V_{FO} | threshold voltage | } for power loss calculation only | $T_{VJ} = 150^{\circ}C$ | | 0.76 | V |
| r_F | slope resistance | | | | 9.1 | m Ω |
| R_{thJC} | thermal resistance junction to case | | | | 7 | K/W |
| R_{thCH} | thermal resistance case to heatsink | | | 1 | | K/W |
| P_{tot} | total power dissipation | | $T_C = 25^{\circ}C$ | | 17 | W |
| I_{FSM} | max. forward surge current | $t = 10 \text{ ms}; (50 \text{ Hz}), \text{ sine}$ | $T_{VJ} = 45^{\circ}C$ | | 550 | A |
| | | $t = 8,3 \text{ ms}; (60 \text{ Hz}), \text{ sine}$ | $V_R = 0 V$ | | 595 | A |
| | | $t = 10 \text{ ms}; (50 \text{ Hz}), \text{ sine}$ | $T_{VJ} = 150^{\circ}C$ | | 470 | A |
| | | $t = 8,3 \text{ ms}; (60 \text{ Hz}), \text{ sine}$ | $V_R = 0 V$ | | 505 | A |
| I^2t | value for fusing | $t = 10 \text{ ms}; (50 \text{ Hz}), \text{ sine}$ | $T_{VJ} = 45^{\circ}C$ | | 1.52 | kA ² s |
| | | $t = 8,3 \text{ ms}; (60 \text{ Hz}), \text{ sine}$ | $V_R = 0 V$ | | 1.48 | kA ² s |
| | | $t = 10 \text{ ms}; (50 \text{ Hz}), \text{ sine}$ | $T_{VJ} = 150^{\circ}C$ | | 1.11 | kA ² s |
| | | $t = 8,3 \text{ ms}; (60 \text{ Hz}), \text{ sine}$ | $V_R = 0 V$ | | 1.06 | kA ² s |
| C_J | junction capacitance | $V_R = 400 V; f = 1 \text{ MHz}$ | $T_{VJ} = 25^{\circ}C$ | | 18 | pF |

| Package FO-B | | Ratings | | | | |
|---------------|--|---|------|------|------|------|
| Symbol | Definition | Conditions | min. | typ. | max. | Unit |
| I_{RMS} | RMS current | per terminal | | | 100 | A |
| T_{stg} | storage temperature | | -40 | | 125 | °C |
| T_{VJ} | virtual junction temperature | | -40 | | 150 | °C |
| Weight | | | | 19 | | g |
| M_D | mounting torque | | 1.8 | | 2.2 | Nm |
| $d_{Spp/App}$ | creepage distance on surface striking distance through air | terminal to terminal | 9.0 | 7.0 | | mm |
| $d_{Spb/Apb}$ | | terminal to backside | 10.0 | 10.0 | | mm |
| V_{ISOL} | isolation voltage | t = 1 second | 3000 | | | V |
| | | t = 1 minute 50/60 Hz, RMS; $I_{ISOL} \leq 1$ mA | 2500 | | | V |

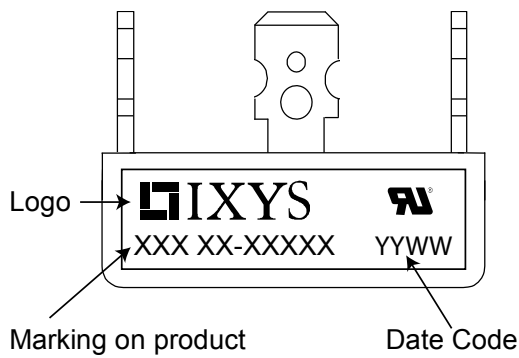

| Ordering | Part Number | Marking on Product | Delivery Mode | Quantity | Code No. |
|----------|-------------|--------------------|---------------|----------|----------|
| Standard | VBO36-18NO8 | VBO36-18NO8 | Box | 50 | 483184 |

Equivalent Circuits for Simulation

* on die level

$T_{VJ} = 150^\circ\text{C}$

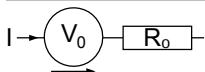

Rectifier

| | | | |
|-------------|--------------------|------|----|
| $V_{0\max}$ | threshold voltage | 0.76 | V |
| $R_{0\max}$ | slope resistance * | 7.9 | mΩ |

Outlines FO-B

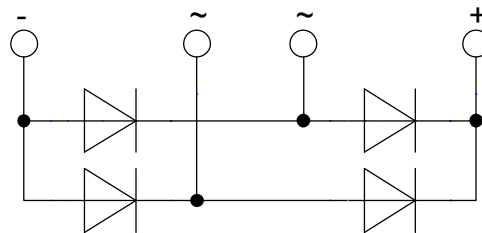
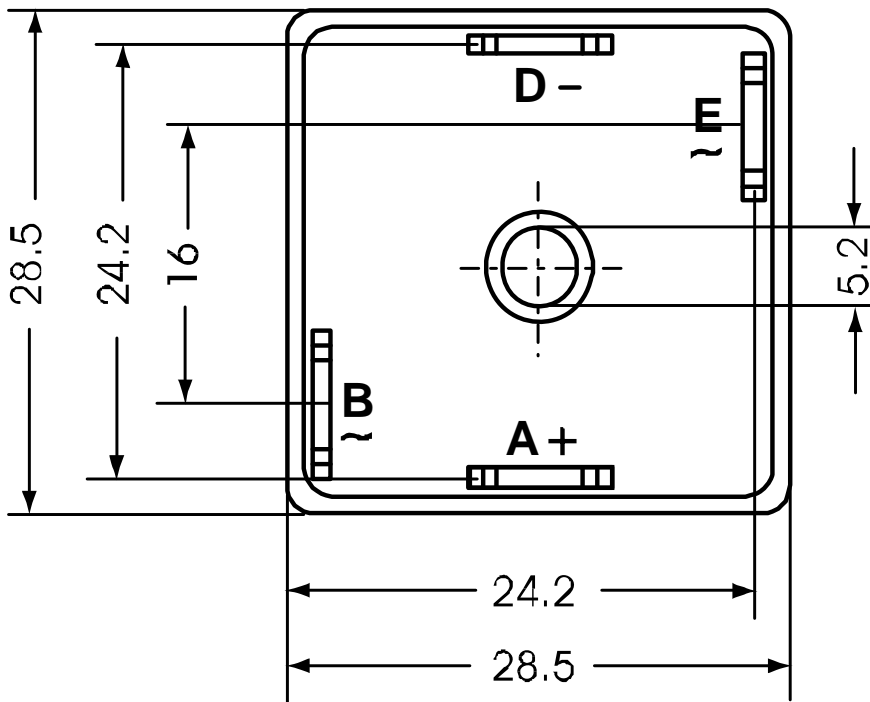
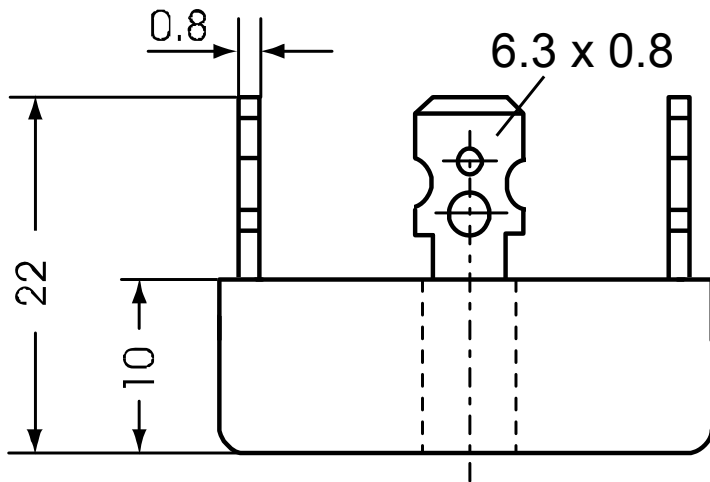

Rectifier

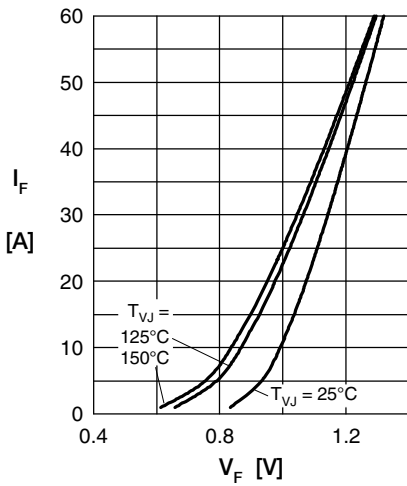

Fig. 1 Forward current vs. voltage drop per diode

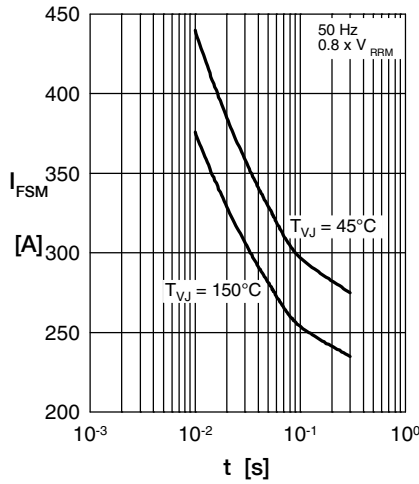

Fig. 2 Surge overload current vs. time per diode

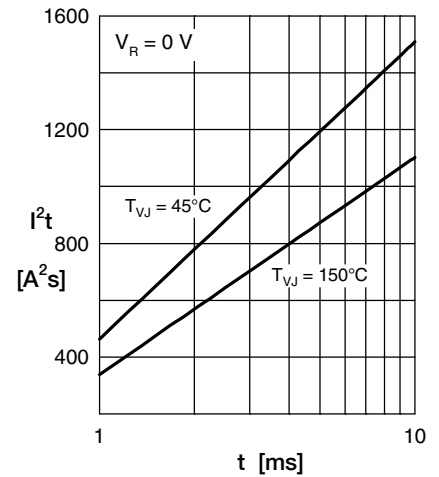

Fig. 3 I^2t vs. time per diode

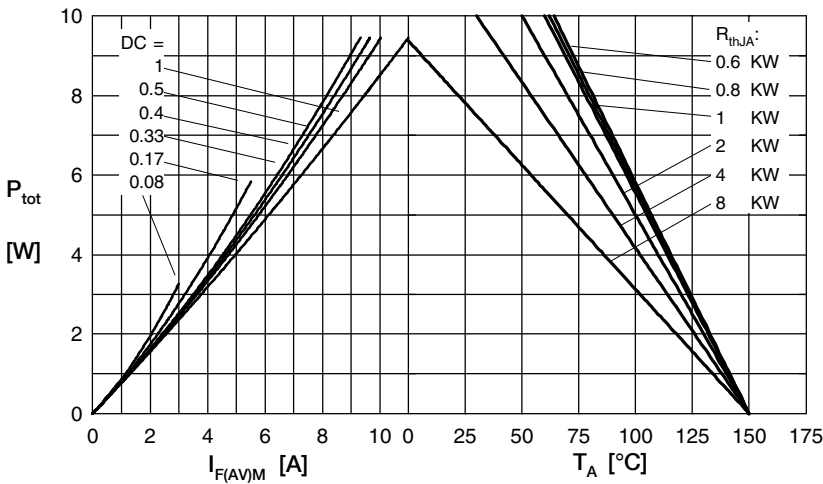

Fig. 4 Power dissipation vs. forward current and ambient temperature per diode

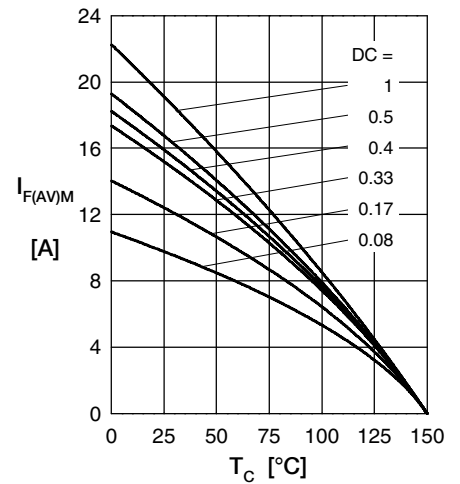

Fig. 5 Max. forward current vs. case temperature per diode

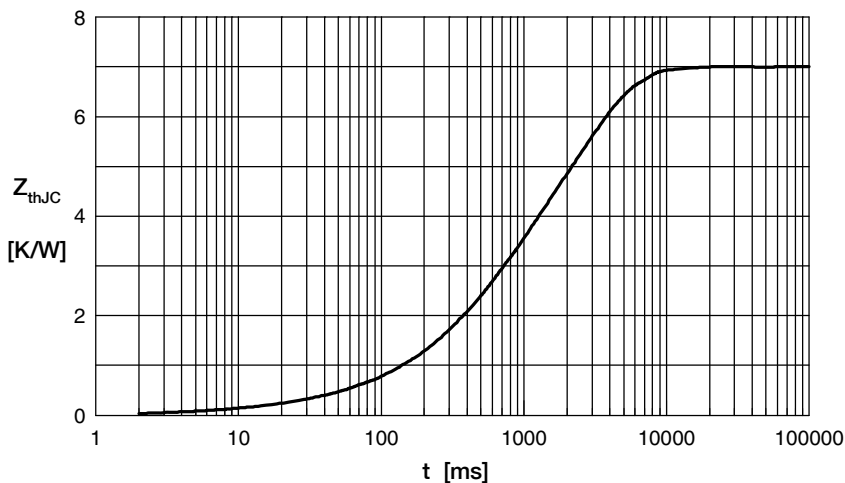

Fig. 6 Transient thermal impedance junction to case vs. time per diode

Constants for Z_{thJC} calculation:

| i | R_{th} (K/W) | t_i (s) |
|---|----------------|-----------|
| 1 | 0.040 | 0.005 |
| 2 | 0.150 | 0.030 |
| 3 | 1.710 | 0.400 |
| 4 | 5.100 | 2.300 |