

N

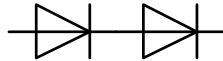

## Datenblatt / Data sheet

**Netz-Dioden-Modul**  
**Rectifier Diode Module**
**DD171N**

 Infineon Technologies Bipolar  
 GmbH & Co. KG

**DD171N**  
**ND171N**
**DD171N..K..-A**
**DD171N..K..-K**
**Elektrische Eigenschaften / Electrical properties**

Höchstzulässige Werte / Maximum rated values

|  |  |             |              |                    |                                      |
|--|--|-------------|--------------|--------------------|--------------------------------------|
| Periodische Spitzensperrspannung<br>repetitive peak reverse voltages | $T_{vj} = -40^{\circ}\text{C} \dots T_{vj\text{max}}$  | $V_{RRM}$   | 1200<br>1600 | 1400<br>1800       | V<br>V                               |
| Stoßspitzensperrspannung<br>non-repetitive peak reverse voltage      | $T_{vj} = +25^{\circ}\text{C} \dots T_{vj\text{max}}$  | $V_{RSM}$   | 1300<br>1700 | 1500<br>1900       | V<br>V                               |
| Durchlaßstrom-Grenzeffektivwert<br>maximum RMS on-state current      |  | $I_{FRMSM}$ |              | 270                | A                                    |
| Dauergrenzstrom<br>average on-state current                          | $T_C = 100^{\circ}\text{C}$  | $I_{FAVM}$  |              | 171                | A                                    |
| Stoßstrom-Grenzwert<br>surge current                                 | $T_{vj} = 25^{\circ}\text{C}, t_p = 10\text{ ms}$<br>$T_{vj} = T_{vj\text{max}}, t_p = 10\text{ ms}$ | $I_{FSM}$   |              | 6.600<br>5.600     | A<br>A                               |
| Grenzlastintegral<br>$I^2t$ -value                                   | $T_{vj} = 25^{\circ}\text{C}, t_p = 10\text{ ms}$<br>$T_{vj} = T_{vj\text{max}}, t_p = 10\text{ ms}$ | $I^2t$      |              | 218.000<br>157.000 | A <sup>2</sup> s<br>A <sup>2</sup> s |

## Charakteristische Werte / Characteristic values

|  |  |            |      |            |          |
|--|--|------------|------|------------|----------|
| Durchlaßspannung<br>on-state voltage               | $T_{vj} = T_{vj\text{max}}, I_F = 500\text{ A}$  | $V_F$      | max. | 1,26       | V        |
| Schleusenspannung<br>threshold voltage             | $T_{vj} = T_{vj\text{max}}$  | $V_{(TO)}$ |      | 0,75       | V        |
| Ersatzwiderstand<br>slope resistance               | $T_{vj} = T_{vj\text{max}}$  | $r_T$      |      | 0,8        | mΩ       |
| Sperrstrom<br>reverse current                      | $T_{vj} = T_{vj\text{max}}, V_R = V_{RRM}$   | $i_R$      | max. | 20         | mA       |
| Isolations-Prüfspannung<br>insulation test voltage | RMS, $f = 50\text{ Hz}, t = 1\text{ sec}$<br>RMS, $f = 50\text{ Hz}, t = 1\text{ min}$ | $V_{ISOL}$ |      | 3,0<br>2,5 | kV<br>kV |

**Thermische Eigenschaften / Thermal properties**

|  |  |                    |      |                                  |                              |
|--|--|--------------------|------|----------------------------------|------------------------------|
| Innerer Wärmewiderstand<br>thermal resistance, junction to case        | pro Modul / per Module, $\Theta = 180^{\circ}\text{ sin}$<br>pro Zweig / per arm, $\Theta = 180^{\circ}\text{ sin}$<br>pro Modul / per Module, DC<br>pro Zweig / per arm, DC | $R_{thJC}$         | max. | 0,130<br>0,260<br>0,126<br>0,252 | °C/W<br>°C/W<br>°C/W<br>°C/W |
| Übergangs-Wärmewiderstand<br>thermal resistance, case to heatsink      | pro Modul / per Module<br>pro Zweig / per arm  | $R_{thCH}$         | max. | 0,03<br>0,06                     | °C/W<br>°C/W                 |
| Höchstzulässige Sperrschichttemperatur<br>maximum junction temperature |  | $T_{vj\text{max}}$ |      | 150                              | °C                           |
| Betriebstemperatur<br>operating temperature                            |  | $T_{c\text{op}}$   |      | - 40...+150                      | °C                           |
| Lagertemperatur<br>storage temperature                                 |  | $T_{stg}$          |      | - 40...+150                      | °C                           |

|              |           |                      |            |
|--------------|-----------|----------------------|------------|
| prepared by: | A.Glunz   | date of publication: | 2016-01-28 |
| approved by: | M.Leifeld | revision:            | 3.1        |

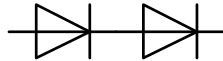
**N****Datenblatt / Data sheet**
**Netz-Dioden-Modul**  
**Rectifier Diode Module**
**DD171N**
 Infineon Technologies Bipolar  
 GmbH & Co. KG
**Mechanische Eigenschaften / Mechanical properties**

|   |               |    |                   |                  |
|---|---------------|----|-------------------|------------------|
| Gehäuse, siehe Anlage<br>case, see annex  |               |    | Seite 3<br>page 3 |                  |
| Si-Element mit Druckkontakt<br>Si-pellet with pressure contact                    |               |    |                   |                  |
| Innere Isolation<br>internal insulation   |               |    | AIN               |                  |
| Anzugsdrehmoment für mechanische Anschlüsse<br>mounting torque                    | Toleranz ±15% | M1 | 6                 | Nm               |
| Anzugsdrehmoment für elektrische Anschlüsse<br>terminal connection torque         | Toleranz ±10% | M2 | 6                 | Nm               |
| Gewicht<br>weight   |               | G  | typ. 310          | g                |
| Kriechstrecke<br>creepage distance  |               |    | 15                | mm               |
| Schwingfestigkeit<br>vibration resistance   | f = 50 Hz     |    | 50                | m/s <sup>2</sup> |
|  | file-No.      |    | E 83336           |                  |

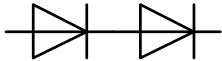
**N**

# Datenblatt / Data sheet



Netz-Dioden-Modul  
Rectifier Diode Module

## DD171N

Infineon Technologies Bipolar  
GmbH & Co. KG

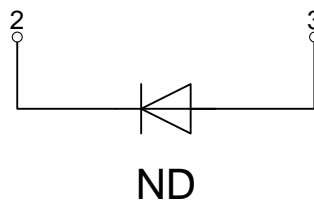
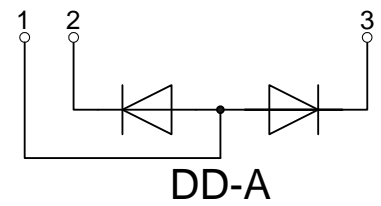
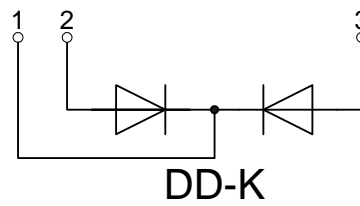
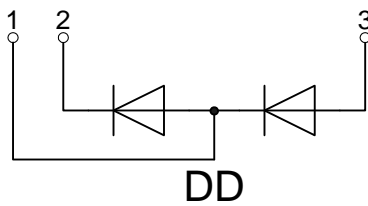
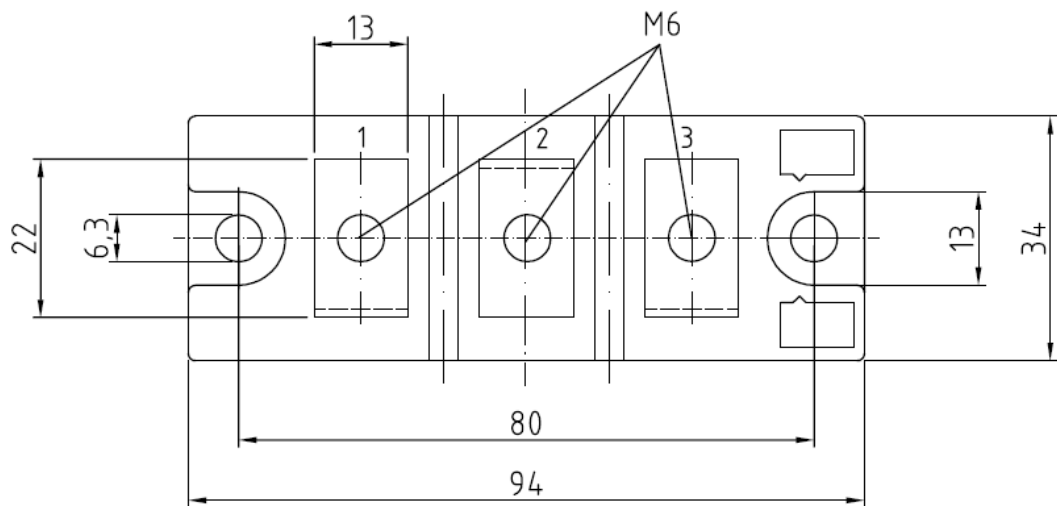
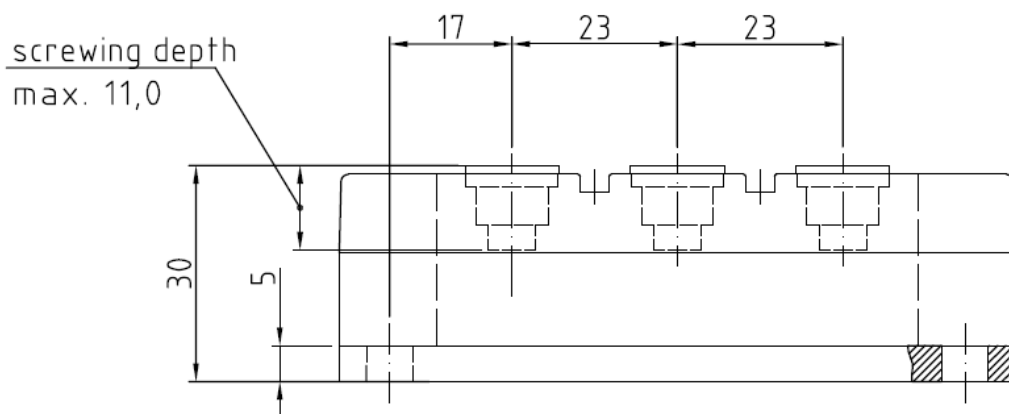

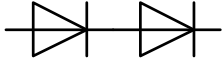

Analytische Elemente des transienten Wärmewiderstandes  $Z_{thJC}$  für DC  
Analytical elements of transient thermal impedance  $Z_{thJC}$  for DC

| Pos. n           | 1      | 2      | 3      | 4     | 5 | 6 | 7 |
|------------------|--------|--------|--------|-------|---|---|---|
| $R_{thn}$ [°C/W] | 0,0094 | 0,0224 | 0,0586 | 0,162 |   |   |   |
| $T_n$ [s]        | 0,0014 | 0,0253 | 0,267  | 1,68  |   |   |   |

Analytische Funktion / Analytical function:

$$Z_{thJC} = \sum_{n=1}^{n_{max}} R_{thn} \left( 1 - e^{-\frac{t}{T_n}} \right)$$

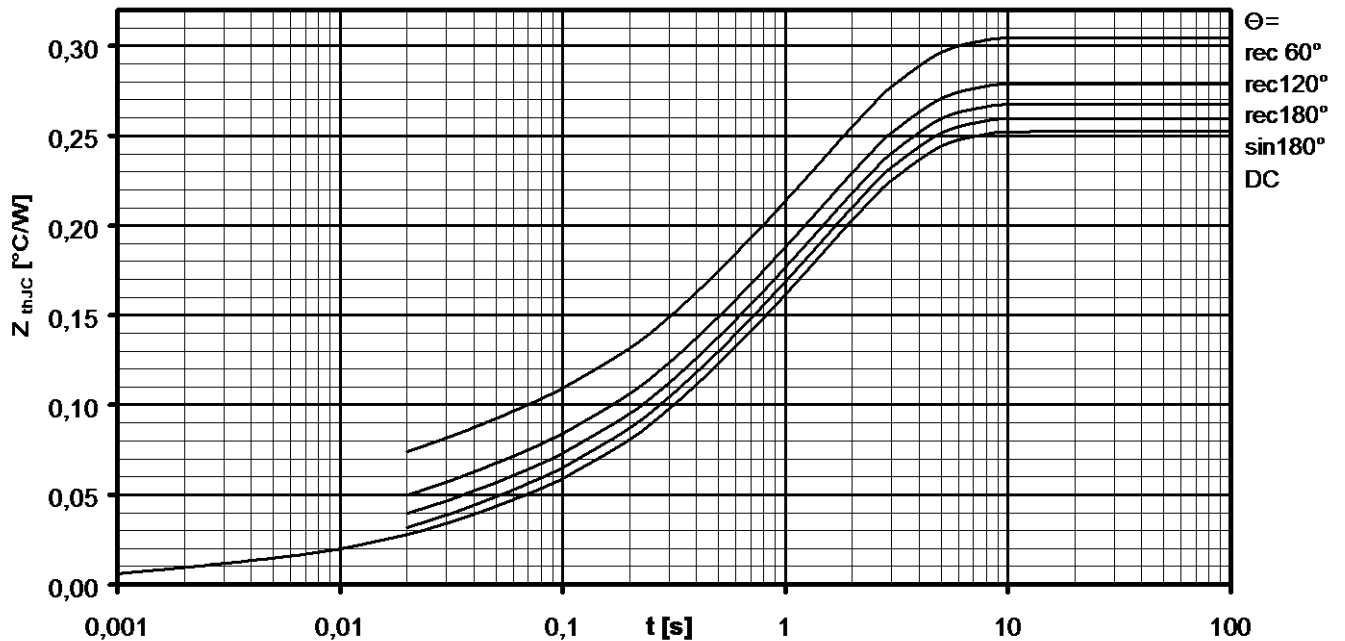

Transienter innerer Wärmewiderstand je Zweig / Transient thermal impedance per arm  $Z_{thJC} = f(t)$

Parameter: Stromflußwinkel  $\Theta$  / Current conduction angle  $\Theta$

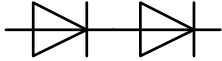

Natürliche Kühlung / Natural cooling  
 3 Module pro Kühler / 3 modules per heatsink  
 Kühler / Heatsink type: KM17 (60W)

**Analytische Elemente des transienten Wärmewiderstandes  $Z_{thCA}$**   
**Analytical elements of transient thermal impedance  $Z_{thCA}$**

| Pos. n           | 1      | 2      | 3     | 4 | 5 | 6 | 7 |
|------------------|--------|--------|-------|---|---|---|---|
| $R_{thn}$ [°C/W] | 0,0505 | 0,1235 | 1,616 |   |   |   |   |
| $T_n$ [s]        | 2,97   | 21,4   | 1180  |   |   |   |   |

Verstärkte Kühlung / Forced cooling  
 3 Module pro Kühler / 3 modules per heatsink  
 Kühler / Heatsink type: KM17 (Papst 4650)

**Analytische Elemente des transienten Wärmewiderstandes  $Z_{thCA}$**   
**Analytical elements of transient thermal impedance  $Z_{thCA}$**

| Pos. n           | 1     | 2     | 3     | 4 | 5 | 6 | 7 |
|------------------|-------|-------|-------|---|---|---|---|
| $R_{thn}$ [°C/W] | 0,026 | 0,119 | 0,515 |   |   |   |   |
| $T_n$ [s]        | 2,41  | 13,6  | 354   |   |   |   |   |

Analytische Funktion / Analytical function:

$$Z_{thCA} = \sum_{n=1}^{n_{max}} R_{thn} \left( 1 - e^{-\frac{t}{T_n}} \right)$$

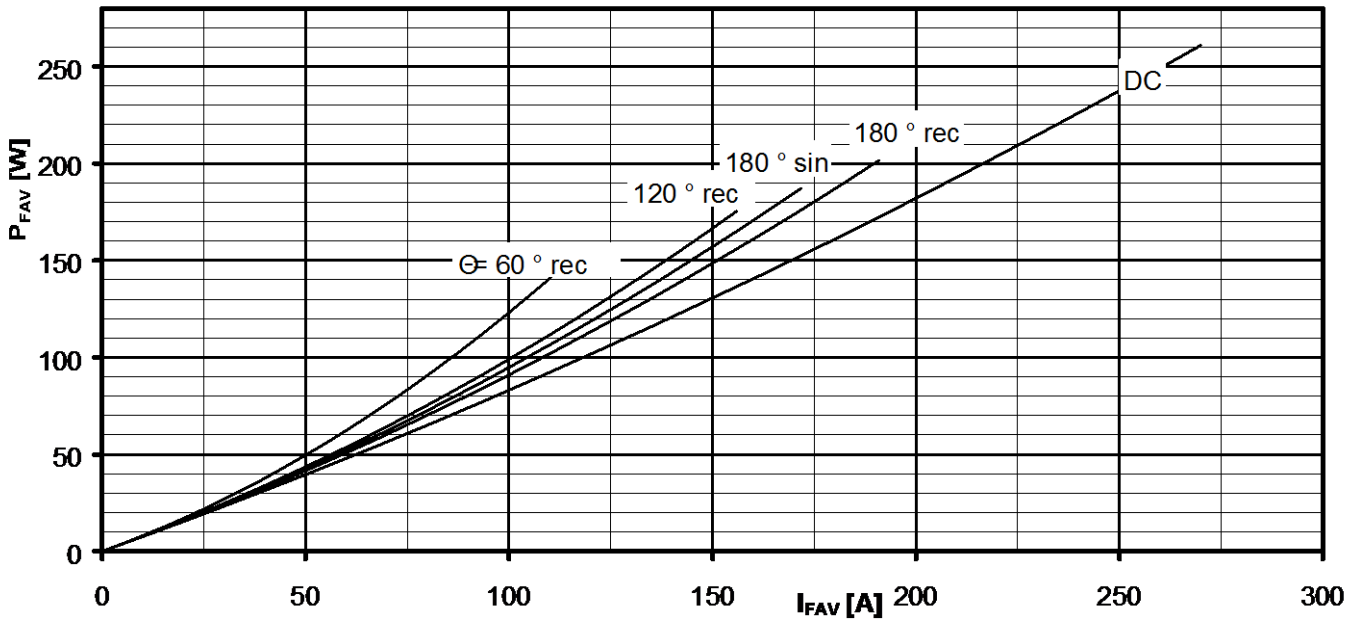
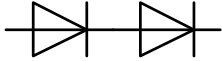

Durchlassverlustleistung je Zweig / On-state power loss per arm  $P_{FAV} = f(I_{FAV})$

Parameter: Stromflußwinkel / Current conduction angle  $\Theta$

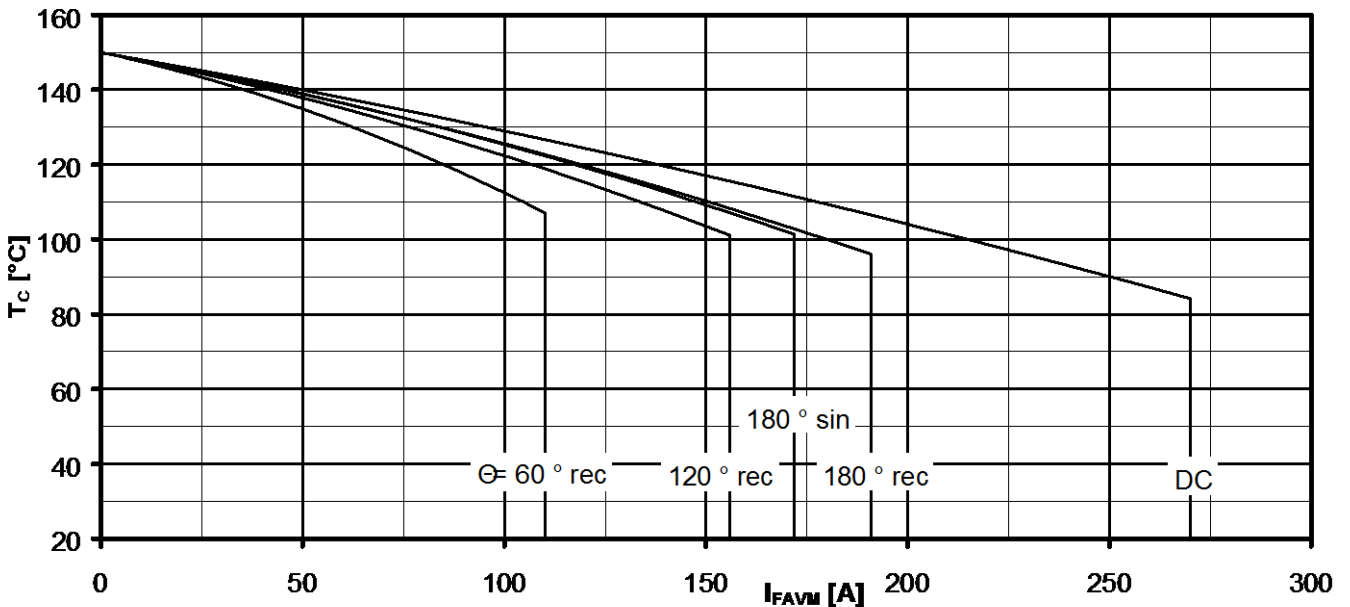

Höchstzulässige Gehäusetemperatur / Maximum allowable case temperature  $T_C = f(I_{FAVM})$

Strombelastung je Zweig / Current load per arm

Berechnungsgrundlage  $P_{TAV}$   
Calculation base  $P_{TAV}$

Parameter: Stromflußwinkel  $\Theta$  / Current conduction angle  $\Theta$

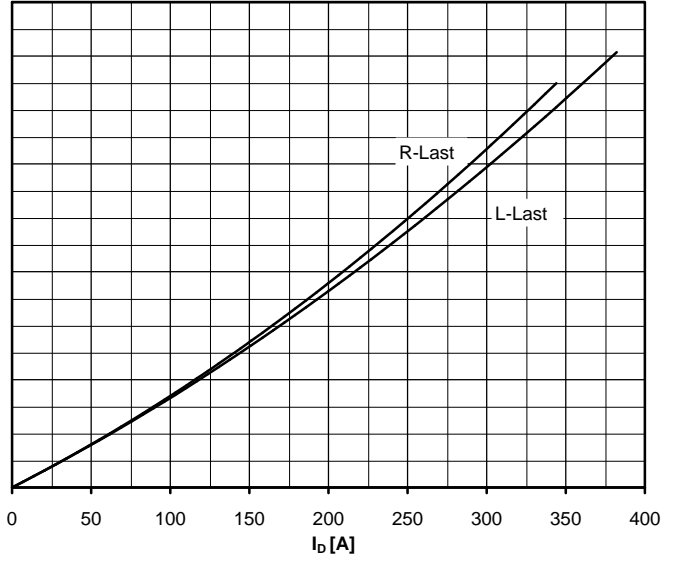
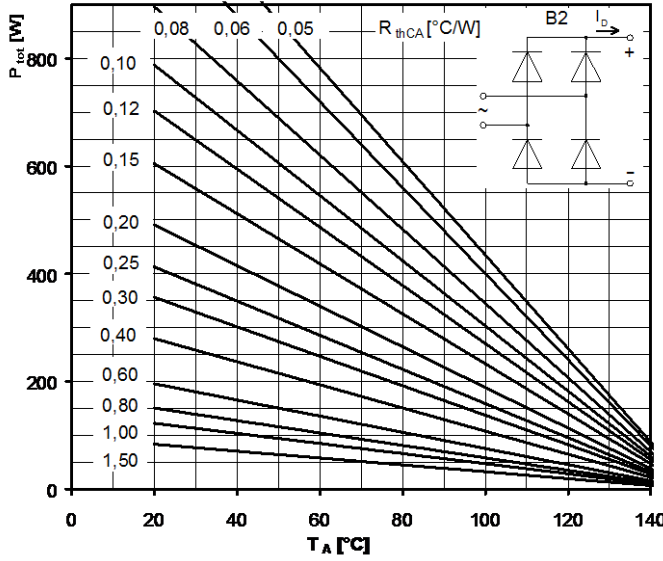
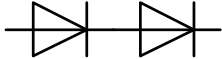

Höchstzulässiger Ausgangsstrom / Maximum rated output current  $I_D$

B2- Zweipuls-Brückenschaltung / Two-pulse bridge circuit

Gesamtverlustleistung der Schaltung / Total power dissipation at circuit  $P_{tot}$

Parameter:

Wärmewiderstand zwischen den Gehäusen und Umgebung / Thermal resistance cases to ambient  $R_{thCA}$

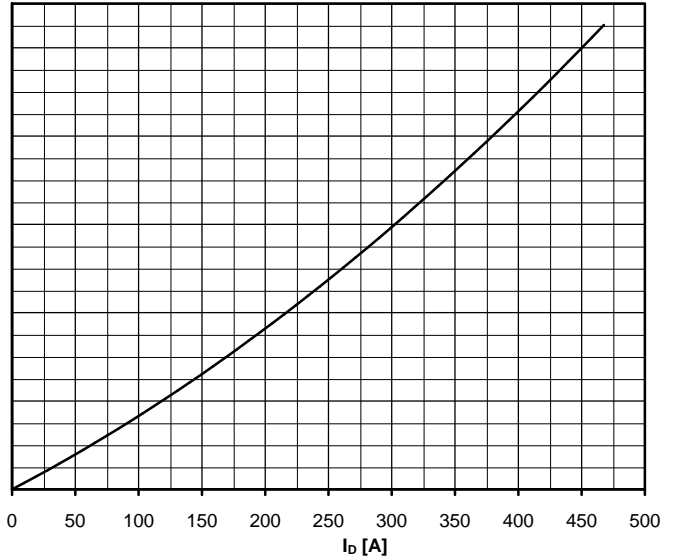
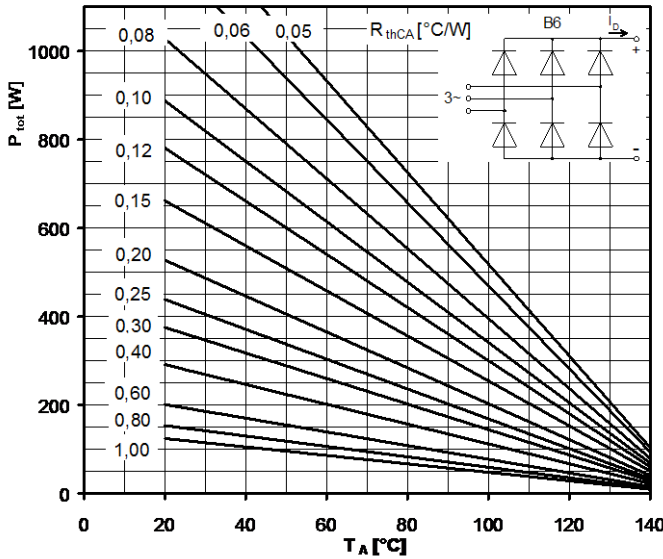

Höchstzulässiger Ausgangsstrom / Maximum rated output current  $I_D$

B6- Sechspuls-Brückenschaltung / Six-pulse bridge circuit

Gesamtverlustleistung der Schaltung / Total power dissipation at circuit  $P_{tot}$

Parameter:

Wärmewiderstand zwischen den Gehäusen und Umgebung / Thermal resistance cases to ambient  $R_{thCA}$

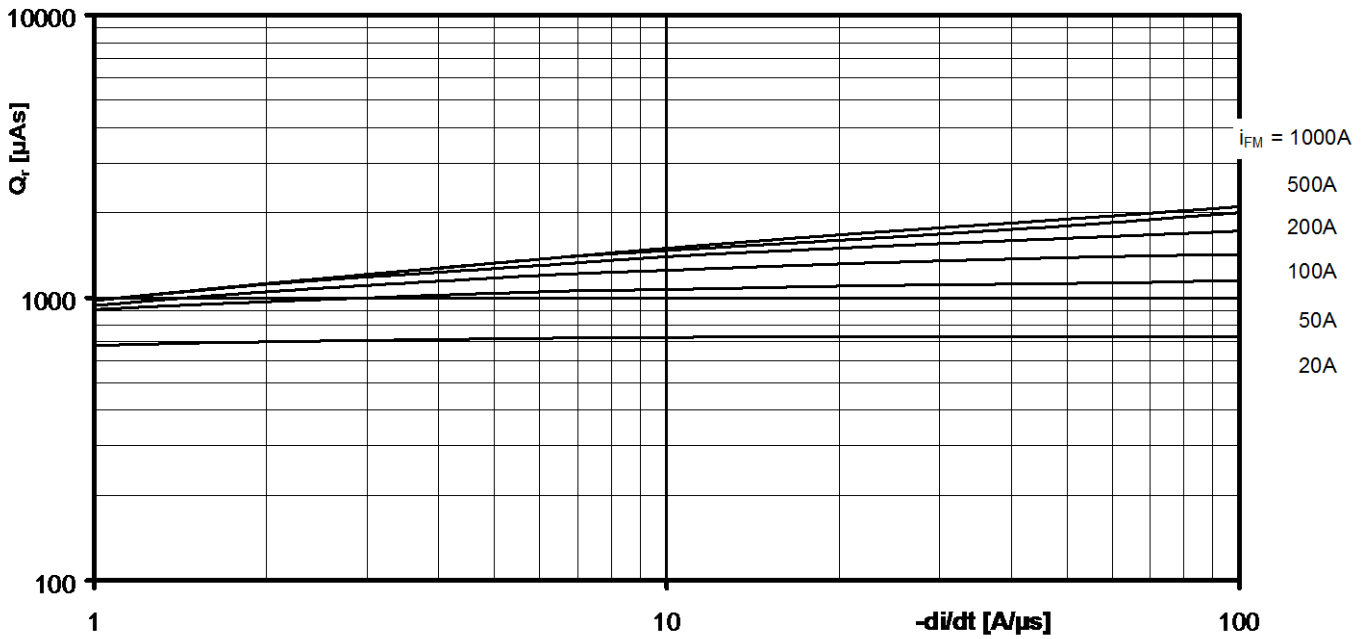
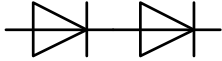

Sperrverzögerungsladung / Recovered charge  $Q_r = f(-di/dt)$

$$T_{vj} = T_{vjmax}, V_R \leq 0,5 V_{RRM}, V_{RM} = 0,8 V_{RRM}$$

Parameter: Durchlaßstrom / On-state current  $i_{FM}$

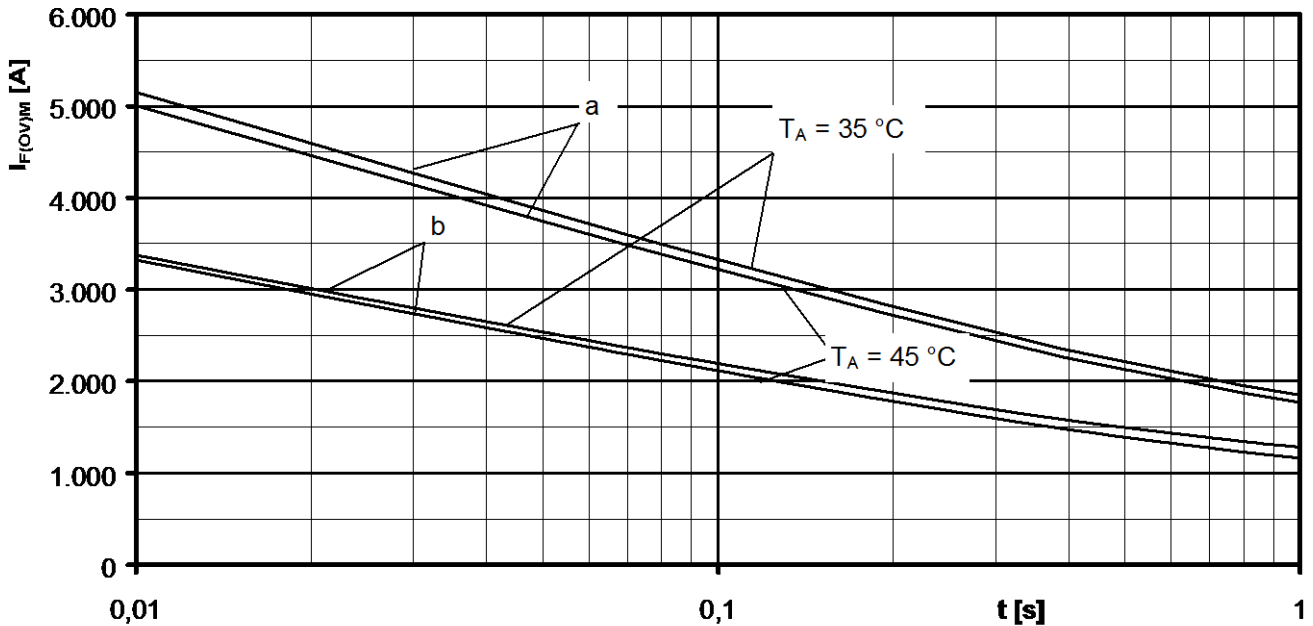

Grenzstrom je Zweig / Maximum overload on-state current per arm  $I_{F(OV)M} = f(t), V_{RM} = 0,8 V_{RRM}$

a: Leerlauf / No-load conditions

b: Vorlaststrom je Zweig / Pre-load current per arm  $I_{FAV(vor)} = I_{FAVM}$

$T_a = 35^\circ\text{C}$ , verstärkte Luftkühlung / Forced air cooling    Kühlkörper / Heatsink type: KM17 (Papst 4650)

$T_a = 45^\circ\text{C}$ , natürliche Luftkühlung / Natural air cooling    Kühlkörper / Heatsink type: KM17 (60W)

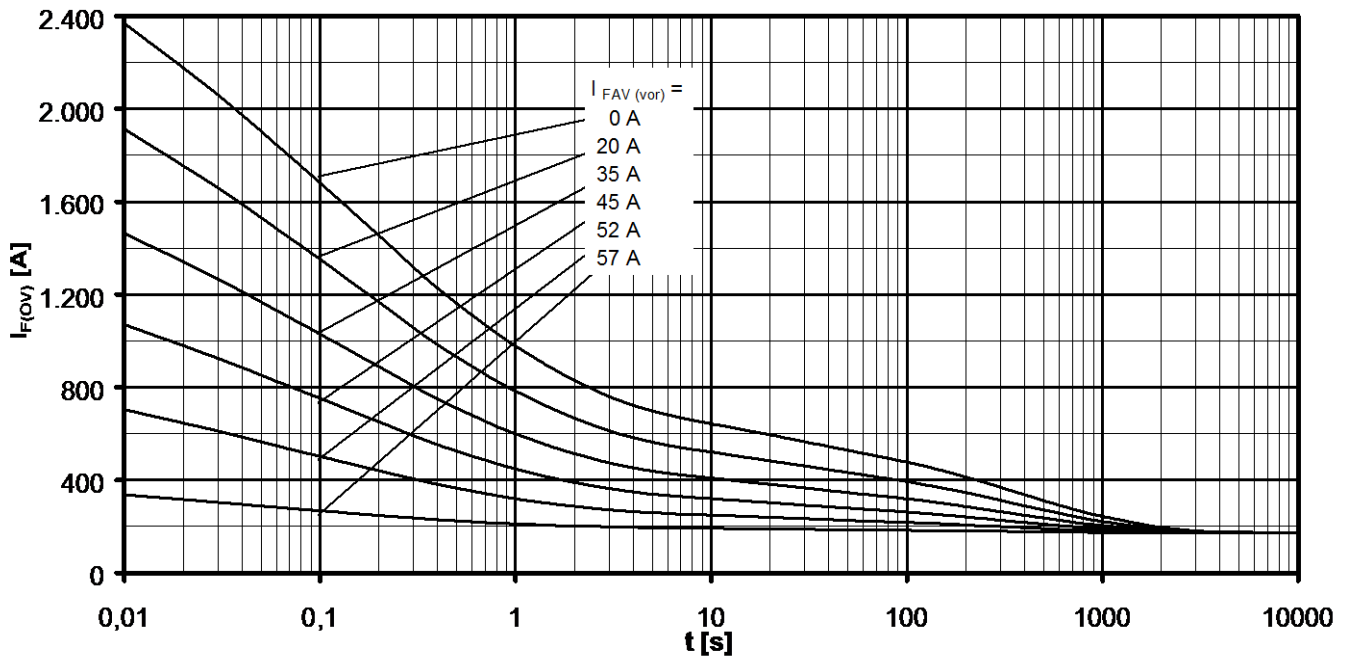
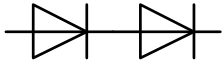

 Überstrom je Zweig / Overload on-state current  $I_{F(ov)}$ 

B6- Sechspuls-Brückenschaltung, 120° Rechteck / Six-pulse bridge circuit, 120° rectangular

 Kühlkörper / Heatsink type KM17 (60W) Natürliche Kühlung bei / Natural cooling at  $T_A = 45^\circ\text{C}$ 

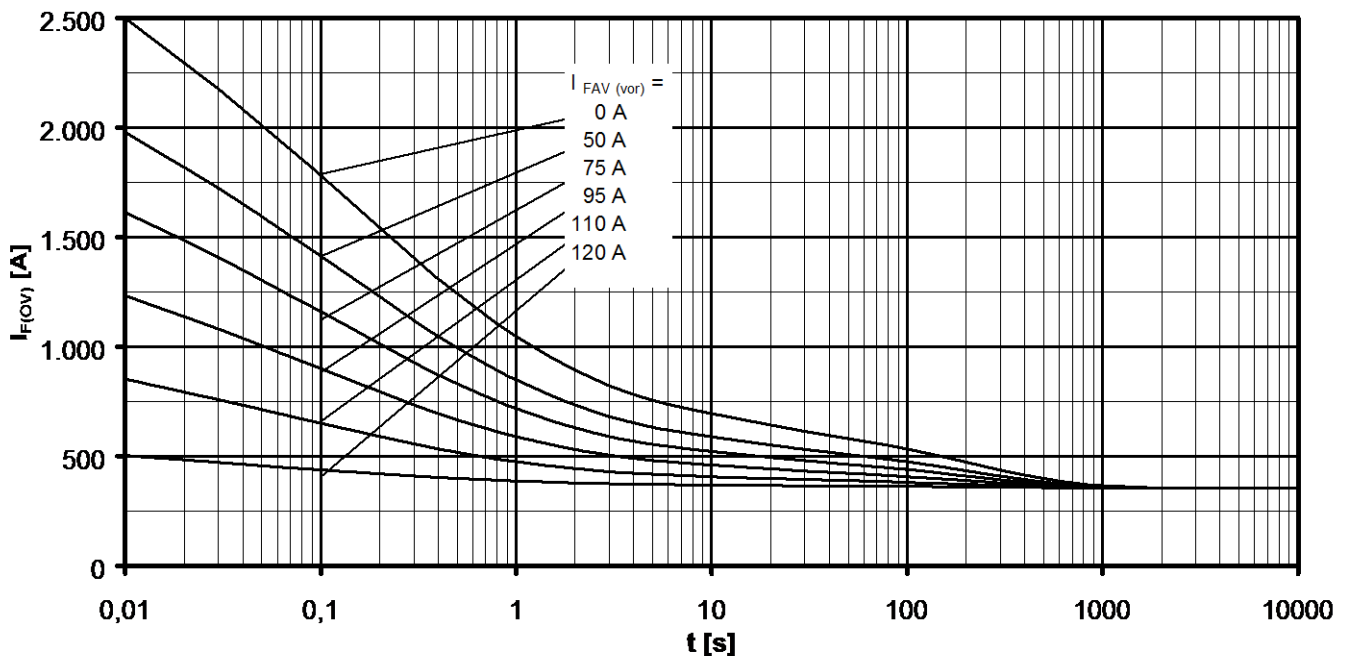
 Parameter: Vorlaststrom je Zweig / Pre-load current per arm  $I_{FAV(vor)}$ 

 Überstrom je Zweig / Overload on-state current  $I_{F(ov)}$ 

B6- Sechspuls-Brückenschaltung, 120° Rechteck / Six-pulse bridge circuit 120° rectangular

 Kühlkörper / Heatsink type KM17 (Papst 4650) Verstärkte Kühlung bei / Forced cooling at  $T_A = 35^\circ\text{C}$ 

 Parameter: Vorlaststrom je Zweig / Pre-load current per arm  $I_{FAV(vor)}$

**This datasheet has been downloaded from:**

**[datasheet.eeworld.com.cn](http://datasheet.eeworld.com.cn)**

**Free Download**

**Daily Updated Database**

**100% Free Datasheet Search Site**

**100% Free IC Replacement Search Site**

**Convenient Electronic Dictionary**

**Fast Search System**

**[www.EEworld.com.cn](http://www.EEworld.com.cn)**