

# Rectifier Diode

## Types W1748LC180 to W1748LC250

Previous Type No.: SW02-22CXC805

**Absolute Maximum Ratings**

	<b>VOLTAGE RATINGS</b>	<b>MAXIMUM LIMITS</b>	<b>UNITS</b>
V <sub>RRM</sub>	Repetitive peak reverse voltage, (note 1)	1800-2500	V
V <sub>RSM</sub>	Non-repetitive peak reverse voltage, (note 1)	1900-2600	V

	<b>OTHER RATINGS</b>	<b>MAXIMUM LIMITS</b>	<b>UNITS</b>
I <sub>F(AV)M</sub>	Maximum average forward current, T <sub>sink</sub> =55°C, (note 2)	1748	A
I <sub>F(AV)M</sub>	Maximum average forward current, T <sub>sink</sub> =100°C, (note 2)	1288	A
I <sub>F(RMS)M</sub>	Nominal RMS forward current, T <sub>sink</sub> =25°C, (note 2)	3157	A
I <sub>F(d.c.)</sub>	D.C. forward current, T <sub>sink</sub> =25°C, (note 3)	2371	A
I <sub>FSM</sub>	Peak non-repetitive surge t <sub>p</sub> =10ms, V <sub>rm</sub> =60%V <sub>RRM</sub> , (note 4)	15.4	kA
I <sub>FSM2</sub>	Peak non-repetitive surge t <sub>p</sub> =10ms, V <sub>rm</sub> ≤10V, (note 4)	17.7	kA
I <sup>2</sup> t	I <sup>2</sup> t capacity for fusing t <sub>p</sub> =10ms, V <sub>rm</sub> =60%V <sub>RRM</sub> , (note 4)	1.18×10 <sup>6</sup>	A <sup>2</sup> s
I <sup>2</sup> t	I <sup>2</sup> t capacity for fusing t <sub>p</sub> =10ms, V <sub>rm</sub> ≤10V, (note 4)	1.56×10 <sup>6</sup>	A <sup>2</sup> s
T <sub>j op</sub>	Operating temperature range	-40 to +175	°C
T <sub>stg</sub>	Storage temperature range	-40 to +200	°C

Notes:-

- 1) De-rating factor of 0.13% per °C is applicable for T<sub>j</sub> below 25°C.
- 2) Double side cooled, single phase; 50Hz, 180° half-sinewave.
- 3) Double side cooled.
- 4) Half-sinewave, 175°C T<sub>j</sub> initial.

### Characteristics

	PARAMETER	MIN.	TYP.	MAX.	TEST CONDITIONS (Note 1)	UNITS
V <sub>FM</sub>	Maximum peak forward voltage	-	-	1.93	I <sub>FM</sub> =3770A	V
V <sub>T0</sub>	Threshold voltage	-	-	0.87		V
r <sub>T</sub>	Slope resistance	-	-	0.28		mΩ
I <sub>RRM</sub>	Peak reverse current	-	-	30	Rated V <sub>RRM</sub>	mA
R <sub>thJK</sub>	Thermal resistance, junction to heatsink	-	-	0.033	Double side cooled	K/W
		-	-	0.065	Single side cooled	K/W
F	Mounting force	10	-	20	Note 2	kN
W <sub>t</sub>	Weight		340			g

Notes:-

- 1) Unless otherwise indicated T<sub>j</sub>=175°C.
- 2) For other clamp forces, please consult factory.

## Notes on Ratings and Characteristics

### 1.0 Voltage Grade Table

Voltage Grade	$V_{RRM}$ V	$V_{RSM}$ V	$V_R$ DC V
18	1800	1900	1150
22	2200	2300	1350
25	2500	2600	1500

### 2.0 Extension of Voltage Grades

This report is applicable to other voltage grades when supply has been agreed by Sales/Production.

### 3.0 De-rating Factor

A blocking voltage de-rating factor of 0.13%/°C is applicable to this device for  $T_j$  below 25°C.

### 4.0 Snubber Components

When selecting snubber components, care must be taken not to use excessively large values of snubber capacitor or excessively small values of snubber resistor. Such excessive component values may lead to device damage due to the large resultant values of snubber discharge current. If required, please consult the factory for assistance.

### 5.0 Computer Modelling Parameters

#### 5.1 Device Dissipation Calculations

$$I_{AV} = \frac{-V_{T0} + \sqrt{V_{T0}^2 + 4 \cdot ff^2 \cdot r_T \cdot W_{AV}}}{2 \cdot ff^2 \cdot r_T} \quad \text{and:} \quad W_{AV} = \frac{\Delta T}{R_{th}}$$

$$\Delta T = T_{j\max} - T_K$$

Where  $V_{T0}=0.87V$ ,  $r_T=0.28m\Omega$ ,

$R_{th}$  = Supplementary thermal impedance, see table below and

$ff$  = Form factor, see table below.

Supplementary Thermal Impedance				
Conduction Angle	6 phase (60°)	3 phase (120°)	½ wave (180°)	d.c.
Square wave Double Side Cooled	0.0455	0.0393	0.0362	0.0319
Square wave Cathode Side Cooled	0.0753	0.0711	0.0687	0.0646
Sine wave Double Side Cooled	0.0397	0.0350	0.0313	
Sine wave Cathode Side Cooled	0.0699	0.0677	0.0653	

Form Factors				
Conduction Angle	6 phase (60°)	3 phase (120°)	½ wave (180°)	d.c.
Square wave	2.449	1.732	1.414	1
Sine wave	2.778	1.879	1.57	

## 5.2 Calculating $V_F$ using ABCD Coefficients

The on-state characteristic  $I_F$  vs.  $V_F$ , on page 8 is represented in two ways;

- (i) the well established  $V_{T0}$  and  $r_T$  tangent used for rating purposes and
- (ii) a set of constants A, B, C, D, forming the coefficients of the representative equation for  $V_F$  in terms of  $I_F$  given below:

$$V_F = A + B \cdot \ln(I_F) + C \cdot I_F + D \cdot \sqrt{I_F}$$

The constants, derived by curve fitting software, are given below for characteristics at the maximum junction temperature of 175°C. The resulting values for  $V_F$  agree with the true device characteristic over a current range, which is limited to that plotted.

175°C Coefficients	
A	0.3867852
B	0.05612815
C	$0.240698 \times 10^{-3}$
D	$2.821743 \times 10^{-3}$

## 5.3 D.C. Thermal Impedance Calculation

$$r_t = \sum_{p=1}^{p=n} r_p \cdot \left( 1 - e^{\frac{-t}{\tau_p}} \right)$$

Where  $p = 1$  to  $n$ ,  $n$  is the number of terms in the series and:

- $t$  = Duration of heating pulse in seconds.
- $r_t$  = Thermal resistance at time  $t$ .
- $r_p$  = Amplitude of  $p$ th term.
- $\tau_p$  = Time Constant of  $r$ th term.

The coefficients for this device are shown in the tables below:

D.C. Double Side Cooled				
Term	1	2	3	4
$r_p$	0.017719	$4.2406 \times 10^{-3}$	$6.9638 \times 10^{-3}$	$3.04366 \times 10^{-3}$
$\tau_p$	0.708578	0.1435833	0.036152	$2.1308 \times 10^{-3}$

D.C. Single Side Cooled					
Term	1	2	3	4	5
$r_p$	0.04013	$6.3388 \times 10^{-3}$	0.011408	$6.0275 \times 10^{-3}$	$7.2098 \times 10^{-4}$
$\tau_p$	4.07311	2.15774	0.19931	$9.0689 \times 10^{-3}$	$4.66345 \times 10^{-4}$

**Curves**

Figure 1 – Mean forward current vs. power dissipation– Double side cooled

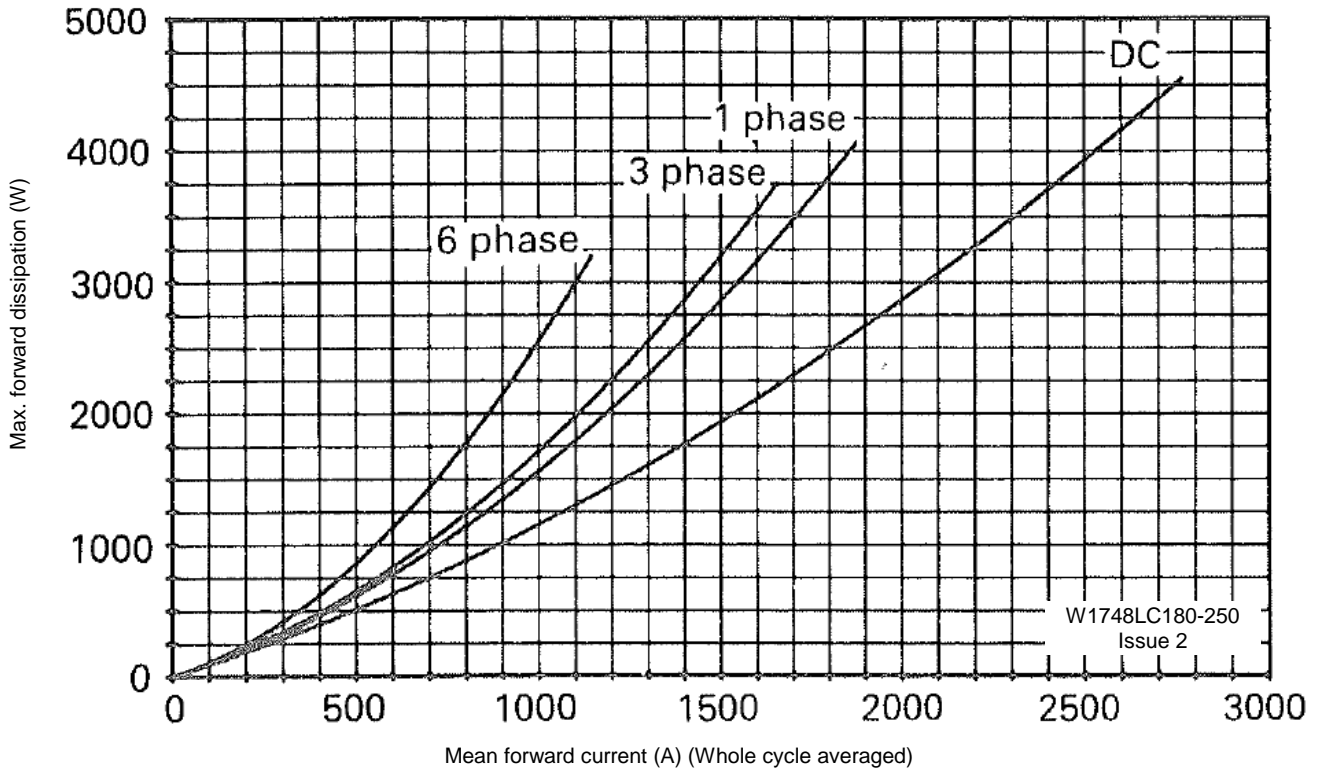

Figure 2 – Mean forward current vs. power dissipation – Single side cooled

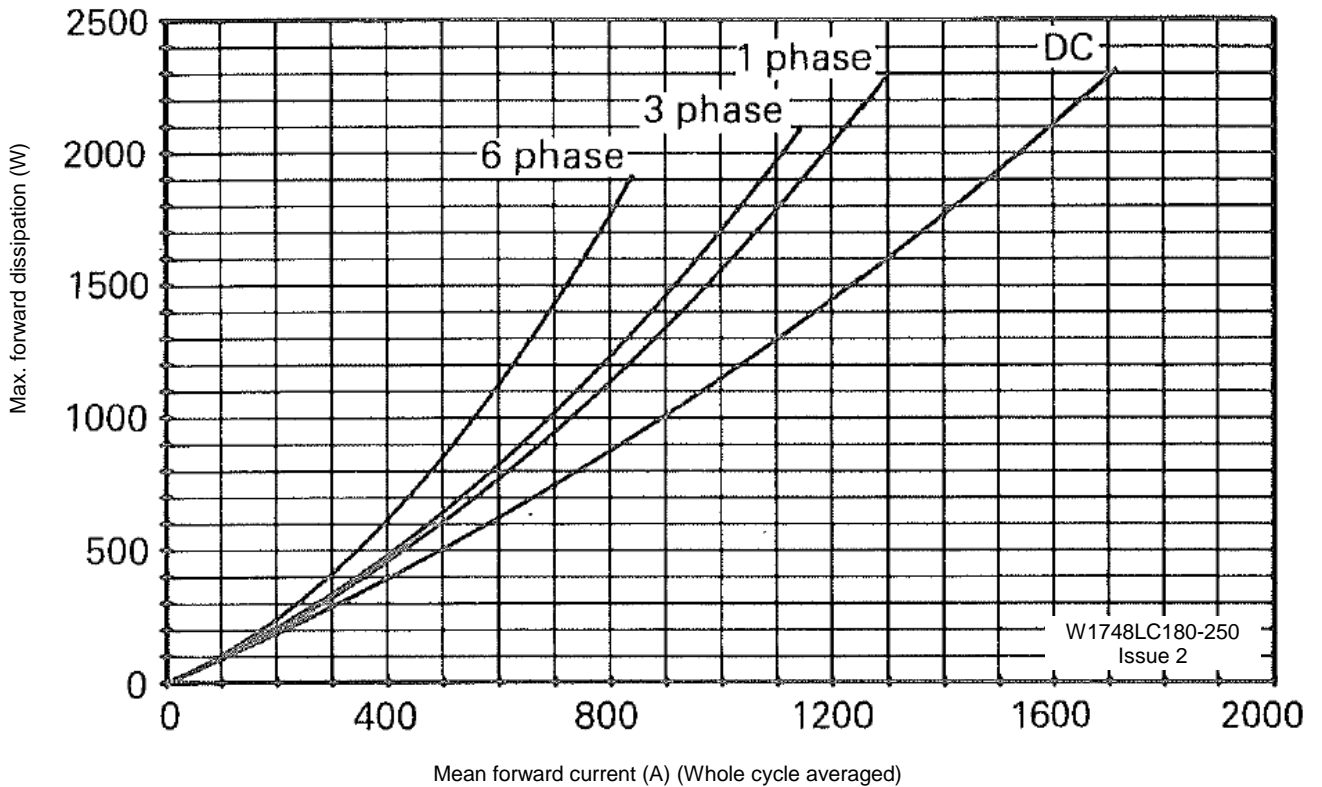

Figure 3 – Max. heatsink temperature vs. mean forward current – Double side cooled

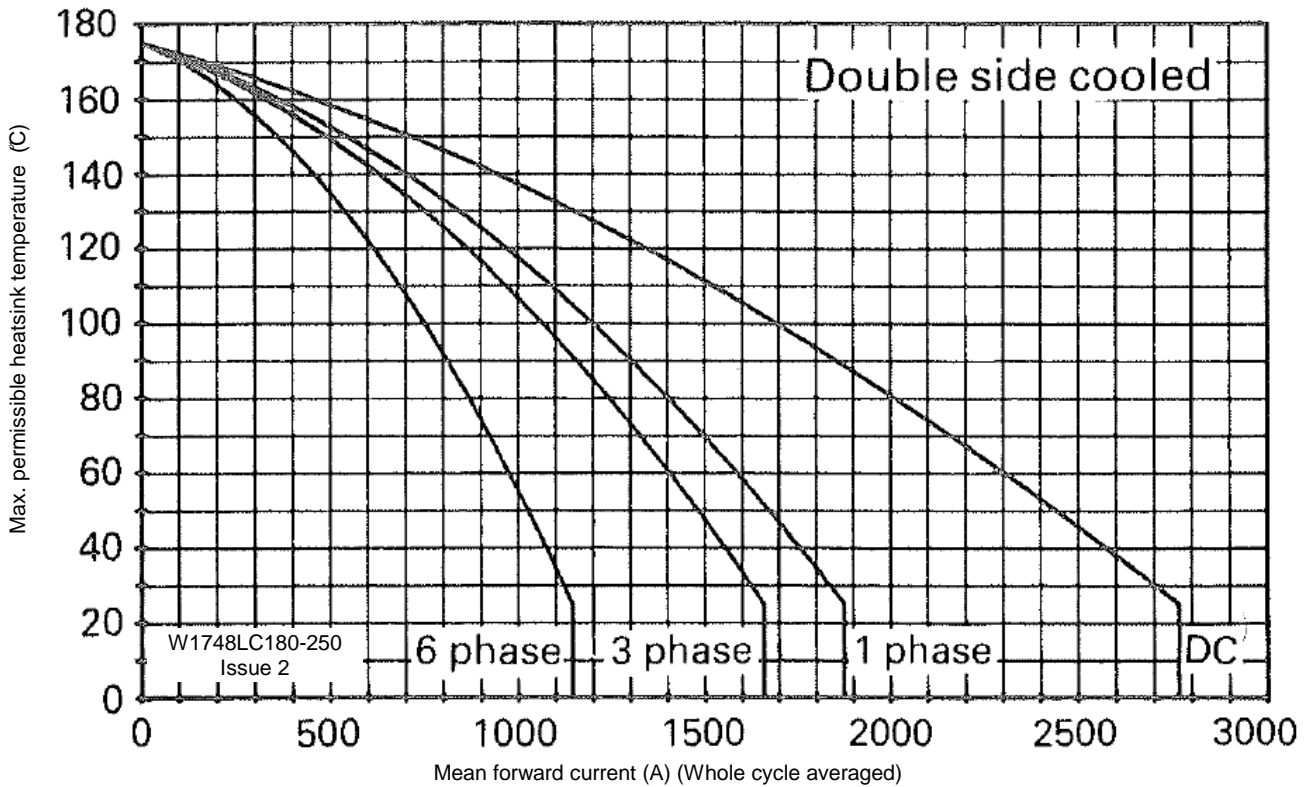

Figure 4 – Max. heatsink temperature vs. mean forward current – Single side cooled

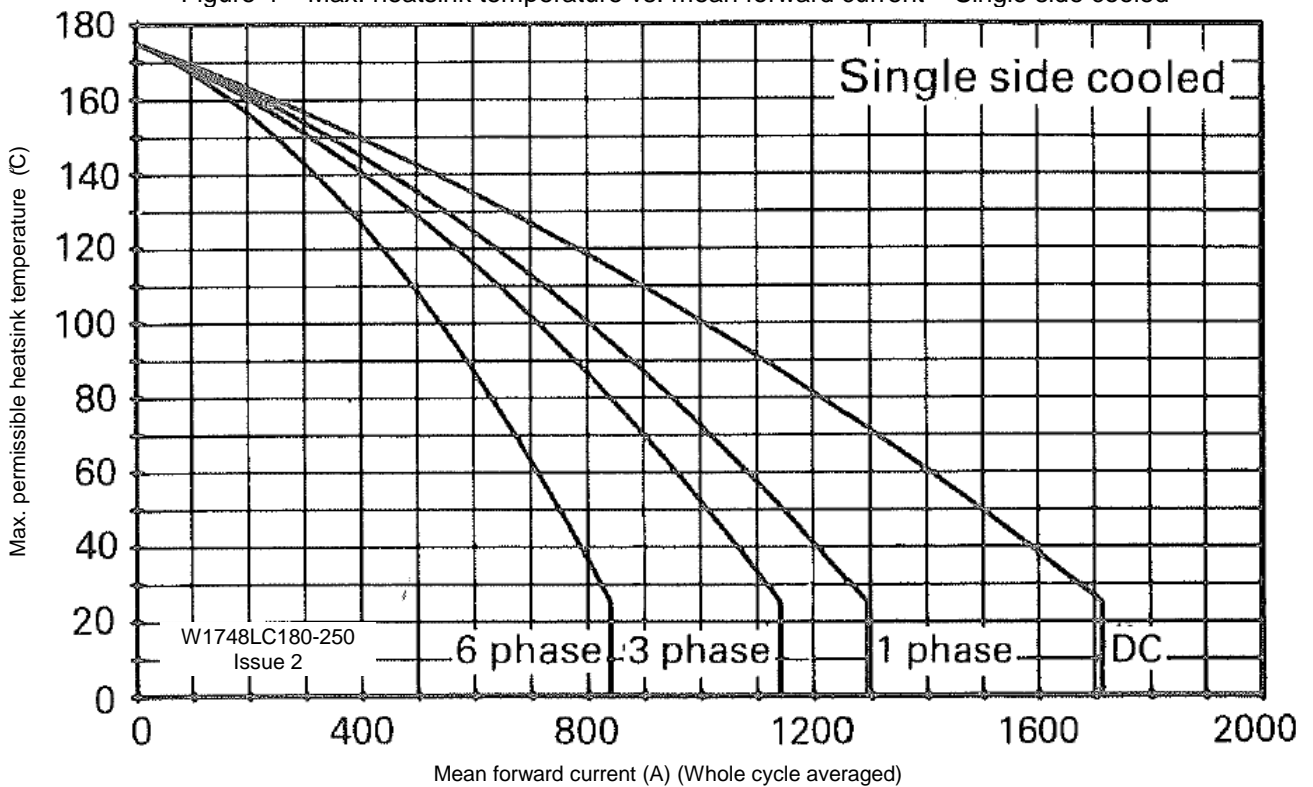

Figure 5 – Forward characteristics of limit device

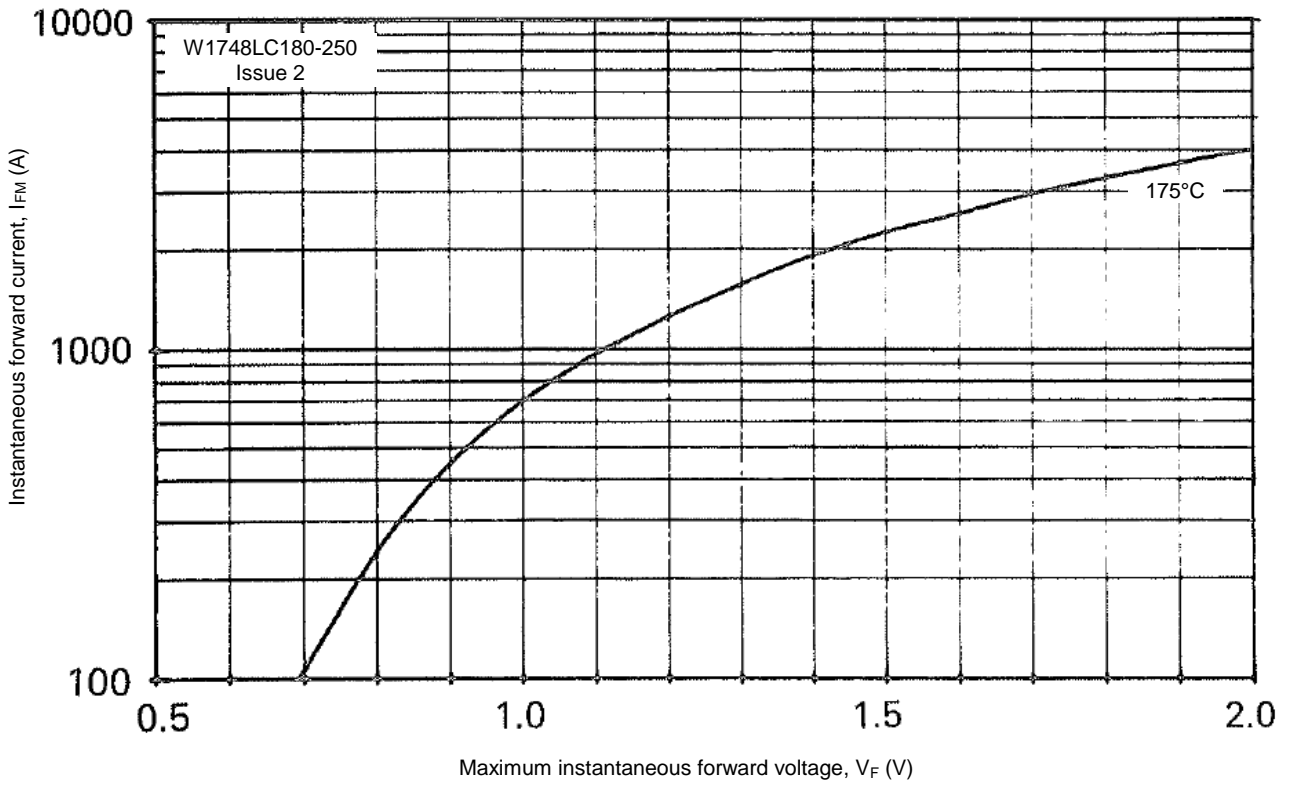

Figure 6 – Transient thermal impedance

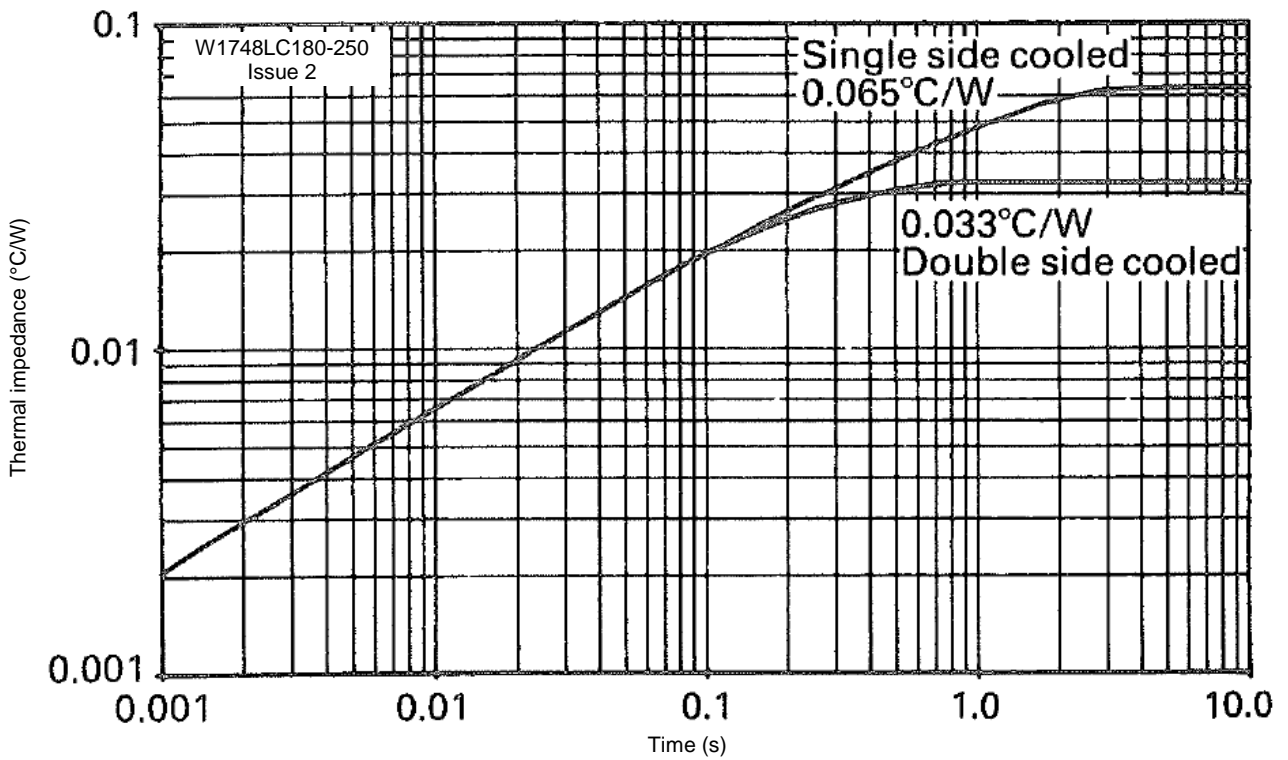
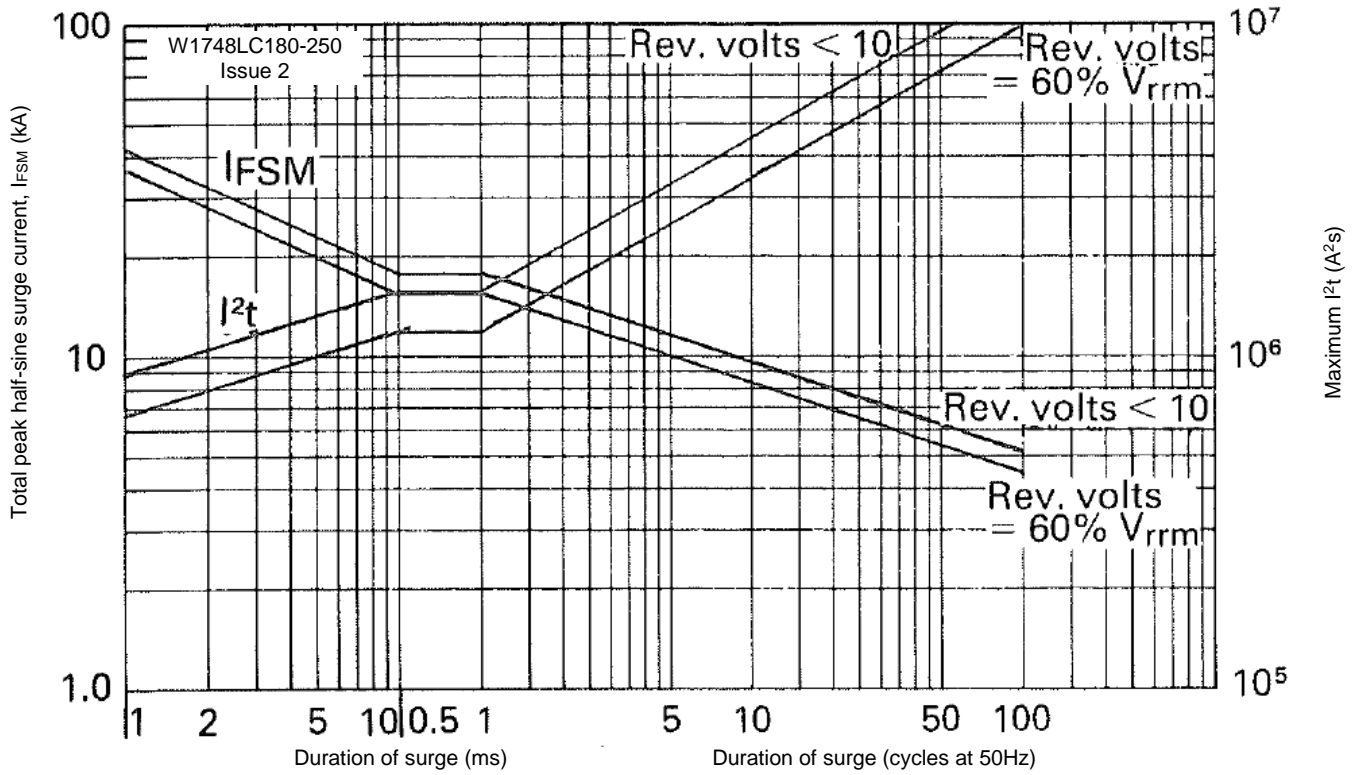
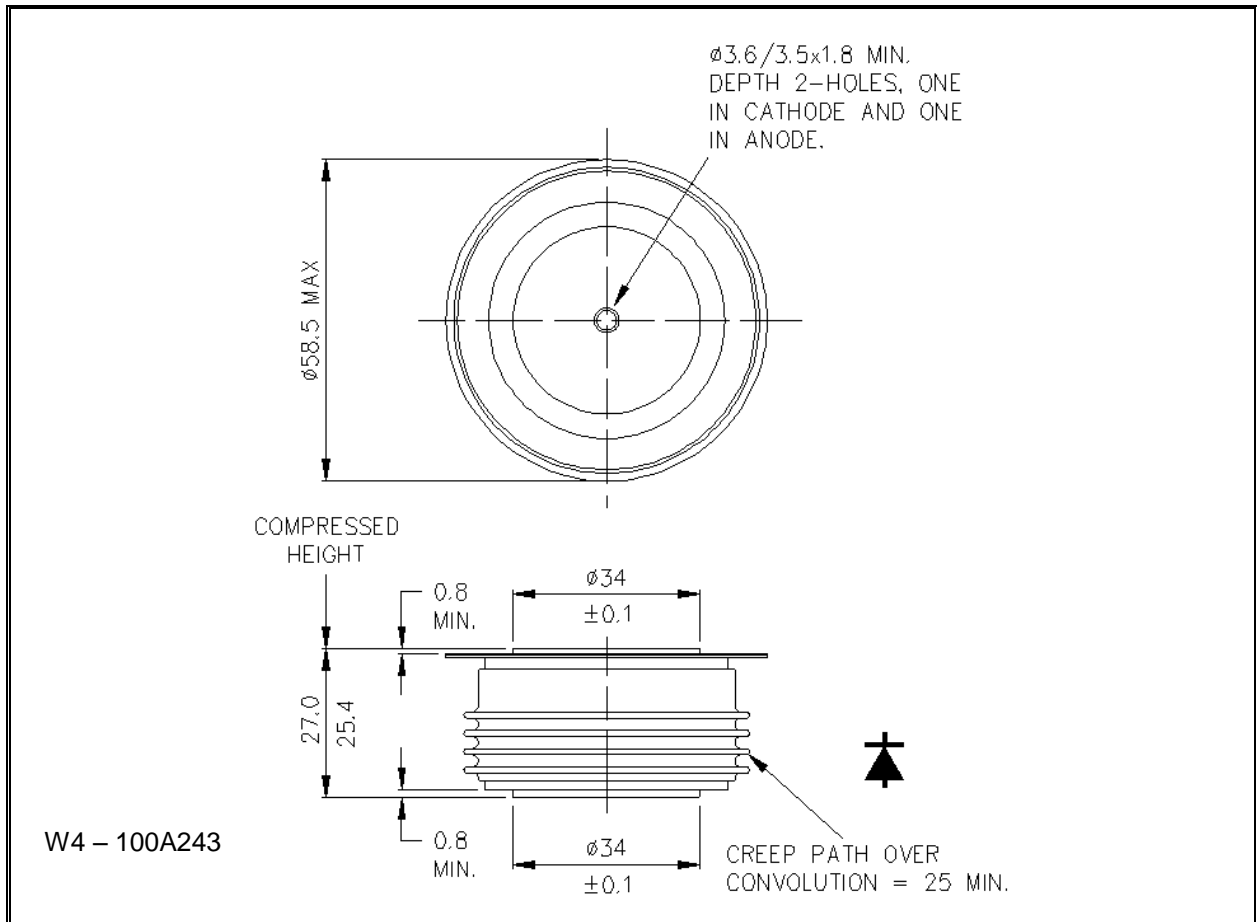



Figure 7 – Maximum non-repetitive surge current at initial junction temperature 160°C



**Outline Drawing & Ordering Information**



ORDERING INFORMATION			
(Please quote 10 digit code as below)			
<b>W1748</b>	<b>LC</b>	<b>◆◆</b>	<b>0</b>
Fixed Type Code	Fixed Outline Code	Voltage code $V_{RRM}/100$ 18-25	Fixed code

Order code: W1748LC250 – 2500V  $V_{RRM}$ , 27mm clamp height capsule.

**IXYS Semiconductor GmbH**  
Edisonstraße 15  
D-68623 Lampertheim  
Tel: +49 6206 503-0  
Fax: +49 6206 503-627  
E-mail: [marcom@ixys.de](mailto:marcom@ixys.de)



**IXYS UK Westcode Ltd**  
Langley Park Way, Langley Park,  
Chippenham, Wiltshire, SN15 1GE.  
Tel: +44 (0)1249 444524  
Fax: +44 (0)1249 659448  
E-mail: [sales@ixysuk.com](mailto:sales@ixysuk.com)

**IXYS Corporation**  
1590 Buckeye Drive  
Milpitas CA 95035-7418  
Tel: +1 (408) 457 9000  
Fax: +1 (408) 496 0670  
E-mail: [sales@ixys.net](mailto:sales@ixys.net)

[www.ixysuk.com](http://www.ixysuk.com)

[www.ixys.com](http://www.ixys.com)

**IXYS Long Beach**  
IXYS Long Beach, Inc  
2500 Mira Mar Ave, Long Beach  
CA 90815  
Tel: +1 (562) 296 6584  
Fax: +1 (562) 296 6585  
E-mail: [service@ixyslongbeach.com](mailto:service@ixyslongbeach.com)

The information contained herein is confidential and is protected by Copyright. The information may not be used or disclosed except with the written permission of and in the manner permitted by the proprietors IXYS UK Westcode Ltd.

© IXYS UK Westcode Ltd.

In the interest of product improvement, IXYS UK Westcode Ltd reserves the right to change specifications at any time without prior notice.

Devices with a suffix code (2-letter, 3-letter or letter/digit/letter combination) added to their generic code are not necessarily subject to the conditions and limits contained in this report.