

# SKNa 26, SKRa 26



Stud Diode

## Avalanche Diode

**SKNa 26**  
**SKRa 26**

### Features

- Avalanche type reverse characteristic up to 2000 V
- Hermetic metal case with glass insulator
- Threaded stud ISO M6 (also 10-21 UNF 2A and M5)<sup>1)</sup>
- Cooling via metal plates or heat sinks
- **SKN**: anode to stud
- **SKR**: cathode to stud

### Typical Applications\*

- DC power supplies for magnets or solenoids (brakes, valves, etc.)
- Field coil supply for DC motors
- Series connections for high voltage applications (dust precipitators)

<sup>1)</sup> M6x1 is standard; "UNF" should be added in description for 10-32 UNF 2A thread, or M5 should be added in description for M5x0,8 thread.

$V_{(BR)min}$	$I_{FRMS} = 40 A$ (maximum value for continuous operation) $I_{FAV} = 26 A$ (sin. 180; $T_c = 69 °C$ )		$C_{max}$	$R_{min}$
V			$\mu F$	$\Omega$
1300	SKNa 26/13	SKRa 26/13		
1700	SKNa 26/17	SKRa 26/17		
2000	SKNa 26/20	SKRa 26/20		

Symbol	Conditions	Values	Units
$I_{FAV}$	sin. 180; $T_c = 86 (101) °C$	22 (18)	A
$I_D$	K 9; $T_a = 45 °C$ ; B2 / B6 K 3; $T_a = 45 °C$ ; B2 / B6	17 / 24 30 / 42	A A
$I_{FSM}$	$T_{vj} = 25 °C$ ; 10 ms $T_{vj} = 150 °C$ ; 10 ms	375 320	A A
$i^2t$	$T_{vj} = 25 °C$ ; 8,3...10 ms $T_{vj} = 150 °C$ ; 8,3...10 ms	700 510	$A^2s$ $A^2s$
$V_F$	$T_{vj} = 25 °C$ ; $I_F = 60 A$	max. 1,55	V
$V_{(TO)}$	$T_{vj} = 150 °C$	max. 0,85	V
$r_T$	$T_{vj} = 150 °C$	max. 11	m $\Omega$
$I_R$	$T_{vj} = 25 °C$ ; $V_R = V_{(BR)min}$	max. 10	$\mu A$
$P_{RSM}$	$T_{vj} = 150 °C$ ; $t_p = 10 \mu s$	6	kW
$R_{th(j-c)}$		2	K/W
$R_{th(c-s)}$		1	K/W
$T_{vj}$		-40...+150	$°C$
$T_{stg}$		-55...+180	$°C$
$V_{isol}$		-	V~
$M_s$		2	Nm
a		5 * 9,81	m/s <sup>2</sup>
m	approx.	7	g
Case		E 8	



SKN



SKR

# SKNa 26, SKRa 26

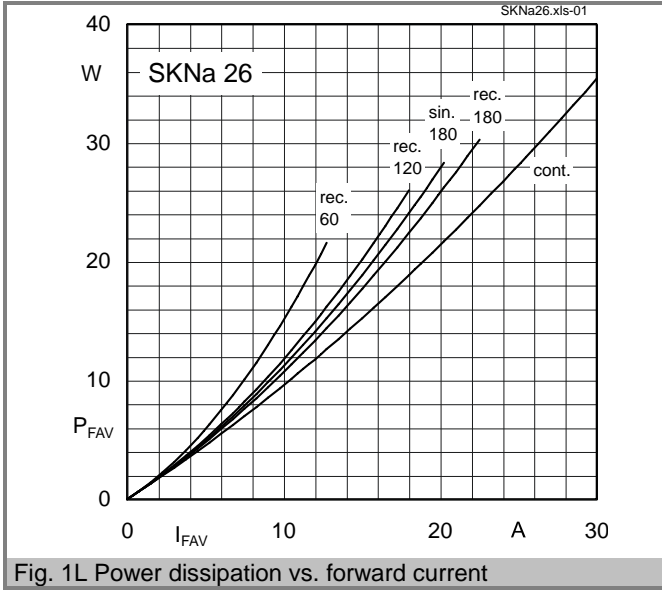

Fig. 1L Power dissipation vs. forward current

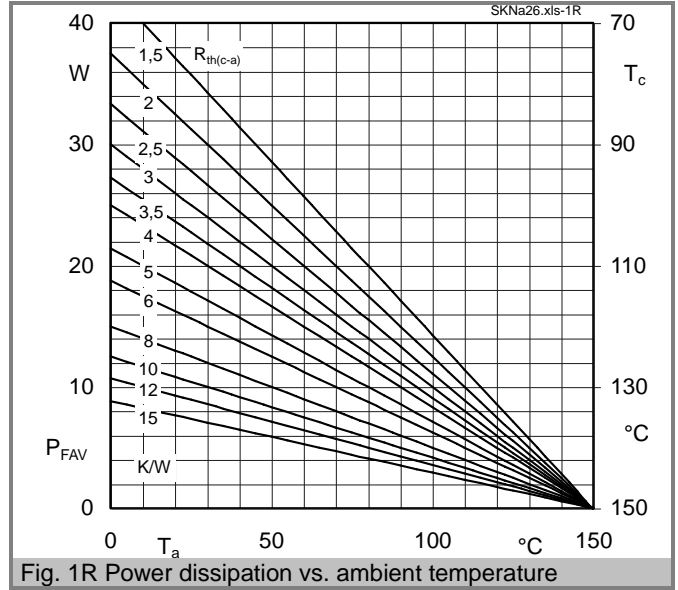

Fig. 1R Power dissipation vs. ambient temperature

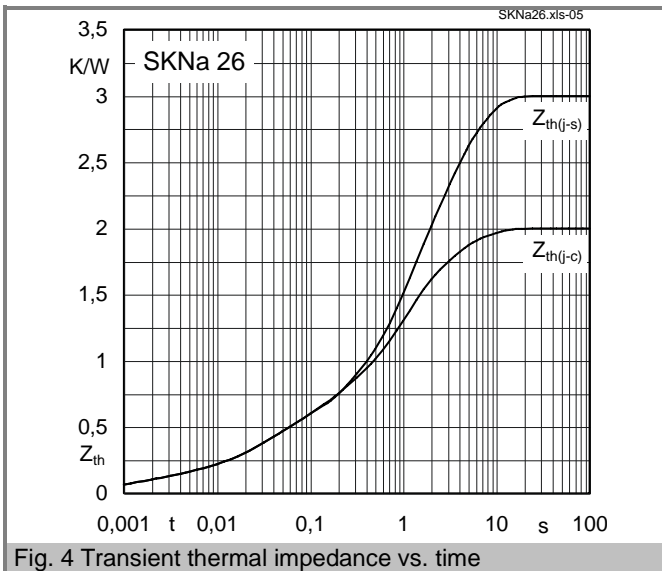

Fig. 4 Transient thermal impedance vs. time

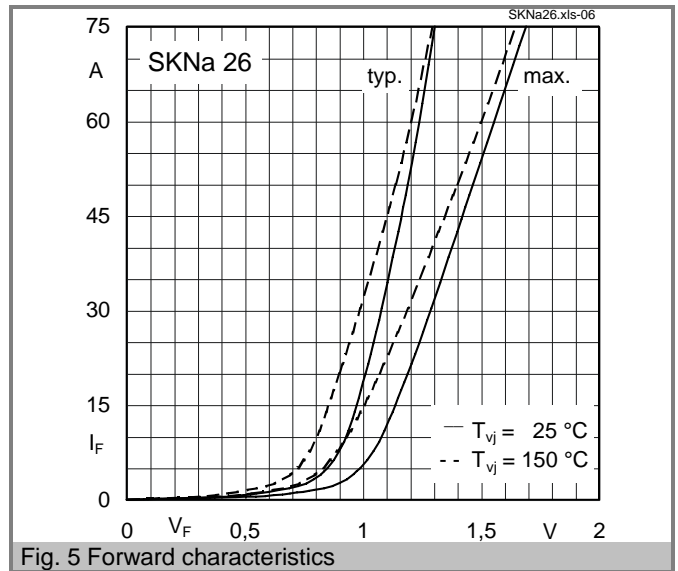

Fig. 5 Forward characteristics

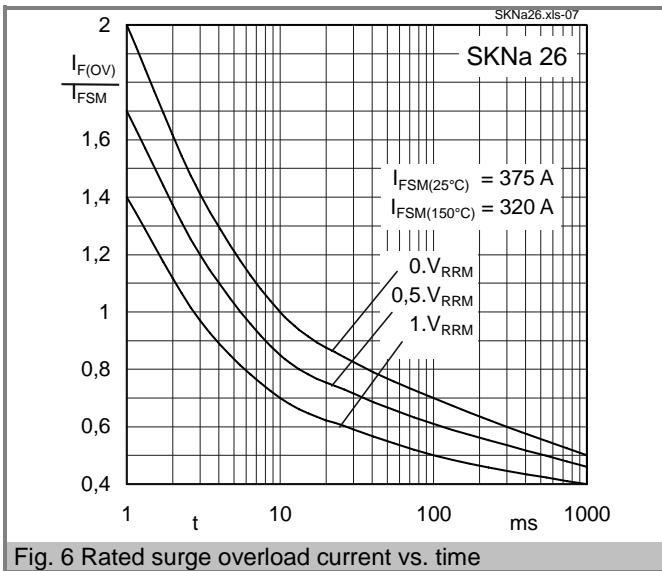

Fig. 6 Rated surge overload current vs. time

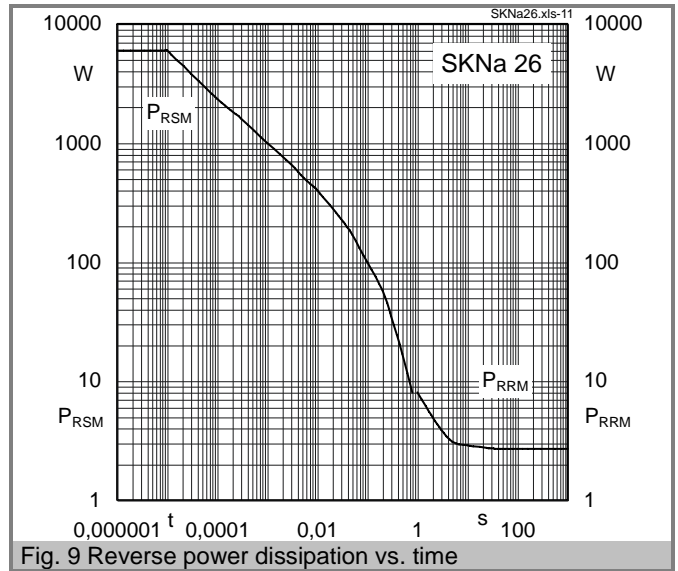
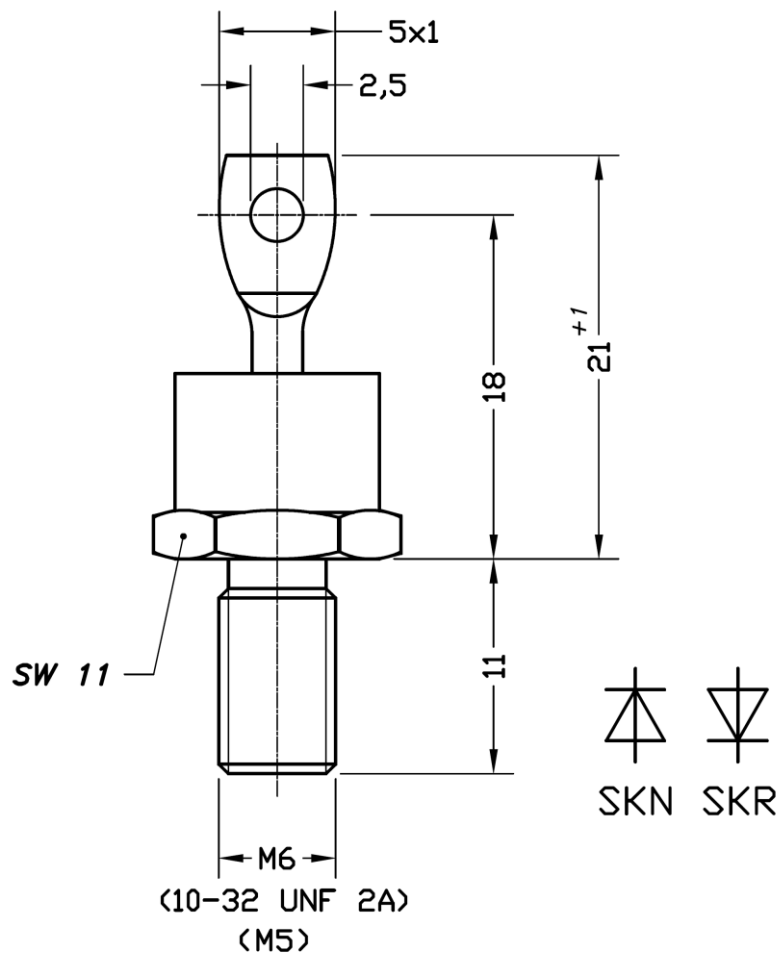

Fig. 9 Reverse power dissipation vs. time



Case E 8 (IEC 60191: A 4 M modified, A 3 U; JEDEC: DO-203 AA)

### \*IMPORTANT INFORMATION AND WARNINGS

The specifications of SEMIKRON products may not be considered as guarantee or assurance of product characteristics ("Beschaffheitsgarantie"). The specifications of SEMIKRON products describe only the usual characteristics of products to be expected in typical applications, which may still vary depending on the specific application. Therefore, products must be tested for the respective application in advance. Application adjustments may be necessary. The user of SEMIKRON products is responsible for the safety of their applications embedding SEMIKRON products and must take adequate safety measures to prevent the applications from causing a physical injury, fire or other problem if any of SEMIKRON products become faulty. The user is responsible to make sure that the application design is compliant with all applicable laws, regulations, norms and standards. Except as otherwise explicitly approved by SEMIKRON in a written document signed by authorized representatives of SEMIKRON, SEMIKRON products may not be used in any applications where a failure of the product or any consequences of the use thereof can reasonably be expected to result in personal injury. No representation or warranty is given and no liability is assumed with respect to the accuracy, completeness and/or use of any information herein, including without limitation, warranties of non-infringement of intellectual property rights of any third party. SEMIKRON does not assume any liability arising out of the applications or use of any product; neither does it convey any license under its patent rights, copyrights, trade secrets or other intellectual property rights, nor the rights of others. SEMIKRON makes no representation or warranty of non-infringement or alleged noninfringement of intellectual property rights of any third party which may arise from applications. Due to technical requirements our products may contain dangerous substances. For information on the types in question please contact the nearest SEMIKRON sales office. This document supersedes and replaces all information previously supplied and may be superseded by updates. SEMIKRON reserves the right to make changes.