

## PHASE CONTROL THYRISTOR

# AT405

Repetitive voltage up to **1200 V**

Mean forward current **304 A**

Surge current **2,8 kA**

### FINAL SPECIFICATION

Feb. 17 - Issue: 6

Symbol	Characteristic	Conditions	T <sub>j</sub> [°C]	Value	Unit
<b>BLOCKING</b>					
V <sub>RRM</sub>	Repetitive peak reverse voltage		125	1200	V
V <sub>RSM</sub>	Non-repetitive peak reverse voltage		125	1300	V
V <sub>DRM</sub>	Repetitive peak off-state voltage		125	1200	V
I <sub>RRM</sub>	Repetitive peak reverse current	V=VRRM	125	30	mA
I <sub>DRM</sub>	Repetitive peak off-state current	V=VDRM	125	30	mA
<b>CONDUCTING</b>					
I <sub>T(AV)</sub>	Mean forward current	180° sin, 50 Hz, Th=55°C, double side cooled		304	A
I <sub>T(AV)</sub>	Mean forward current	180° sin, 50 Hz, Tc=85°C, double side cooled		247	A
I <sub>TSM</sub>	Surge forward current	Sine wave, 10 ms	125	2,8	kA
I <sup>2</sup> t	I <sup>2</sup> t	without reverse voltage		39 x 10 <sup>3</sup>	A <sup>2</sup> s
V <sub>T</sub>	On-state voltage	On-state current = 600 A	25	1,88	V
V <sub>T(TO)</sub>	Threshold voltage		125	1,00	V
r <sub>T</sub>	On-state slope resistance		125	1,900	mohm
<b>SWITCHING</b>					
di/dt	Critical rate of rise of on-state current, min.	From 75% VDRM up to 300 A; gate 10V, 5Ω	125	200	A/μs
dv/dt	Critical rate of rise of off-state voltage, min.	Linear ramp up to 70% of VDRM	125	500	V/μs
t <sub>d</sub>	Gate controlled delay time, typical	VD=100V; gate source 10V, 10Ω, tr=.5 μs	25	0,7	μs
t <sub>q</sub>	Circuit commutated turn-off time, typical	dv/dt = 20 V/μs linear up to 75% VDRM		200	μs
Q <sub>rr</sub>	Reverse recovery charge	di/dt = -20 A/μs, I= 195 A	125		μC
I <sub>rr</sub>	Peak reverse recovery current	VR= 50 V			A
I <sub>H</sub>	Holding current, typical	VD=5V, gate open circuit	25	300	mA
I <sub>L</sub>	Latching current, typical	VD=5V, tp=30μs	25	700	mA
<b>GATE</b>					
V <sub>GT</sub>	Gate trigger voltage	VD=5V	25	3,50	V
I <sub>GT</sub>	Gate trigger current	VD=5V	25	200	mA
V <sub>GD</sub>	Non-trigger gate voltage, min.	VD=VDRM	125	0,25	V
V <sub>FGM</sub>	Peak gate voltage (forward)			20	V
I <sub>FGM</sub>	Peak gate current			8	A
V <sub>RGM</sub>	Peak gate voltage (reverse)			5	V
P <sub>GM</sub>	Peak gate power dissipation	Pulse width 100 μs		75	W
P <sub>G</sub>	Average gate power dissipation			1	W
<b>MOUNTING</b>					
R <sub>th(j-h)</sub>	Thermal impedance, DC	Junction to heatsink, double side cooled		95,0	°C/kW
R <sub>th(c-h)</sub>	Thermal impedance	Case to heatsink, double side cooled		20,0	°C/kW
T <sub>j</sub>	Operating junction temperature			-30 / 125	°C
F	Mounting force			4,9 / 5,9	kN
	Mass			55	g

### ORDERING INFORMATION : AT405 S 12

standard specification   VRRM/100

**DISSIPATION CHARACTERISTICS**

**SQUARE WAVE**

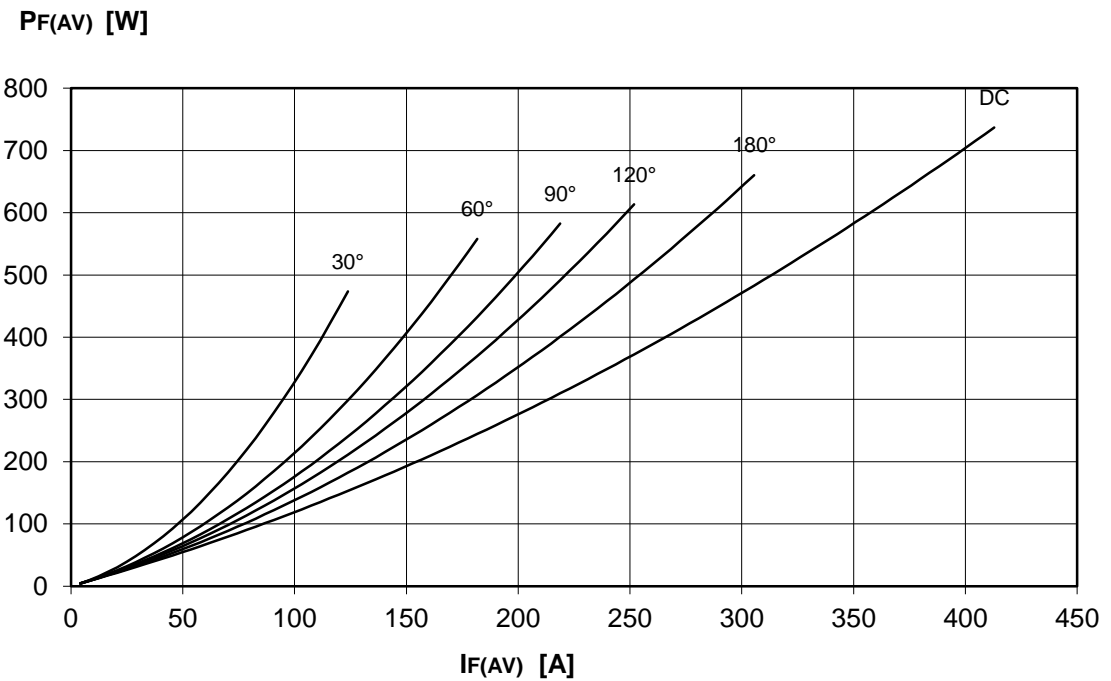
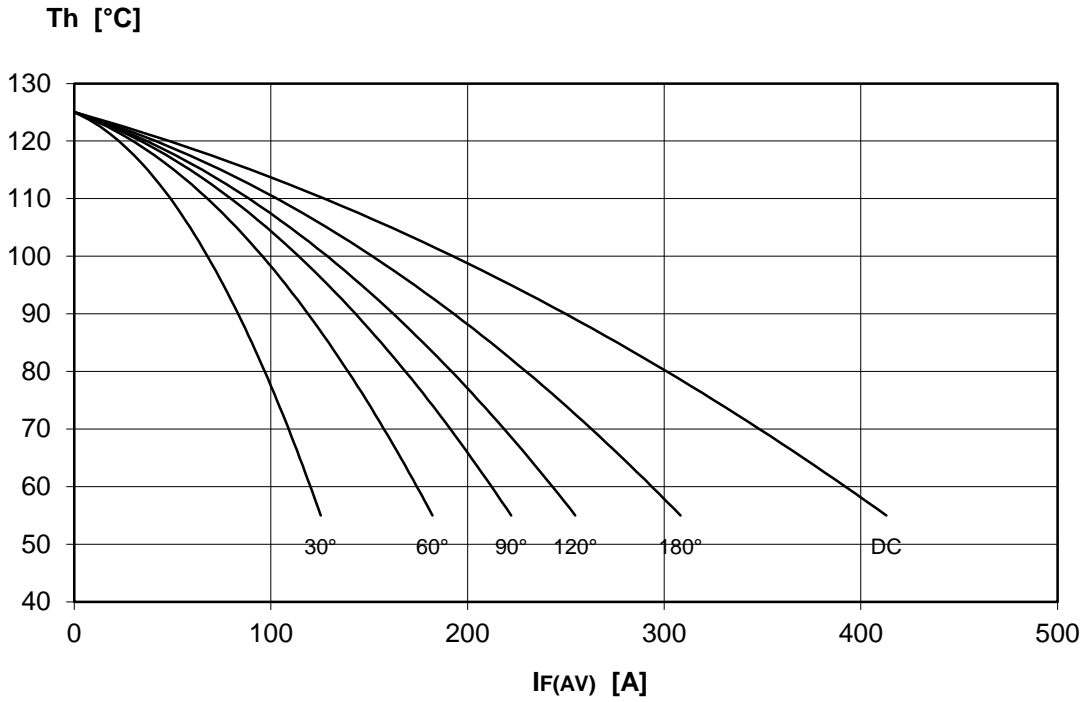

DISSIPATION CHARACTERISTICS

SINE WAVE

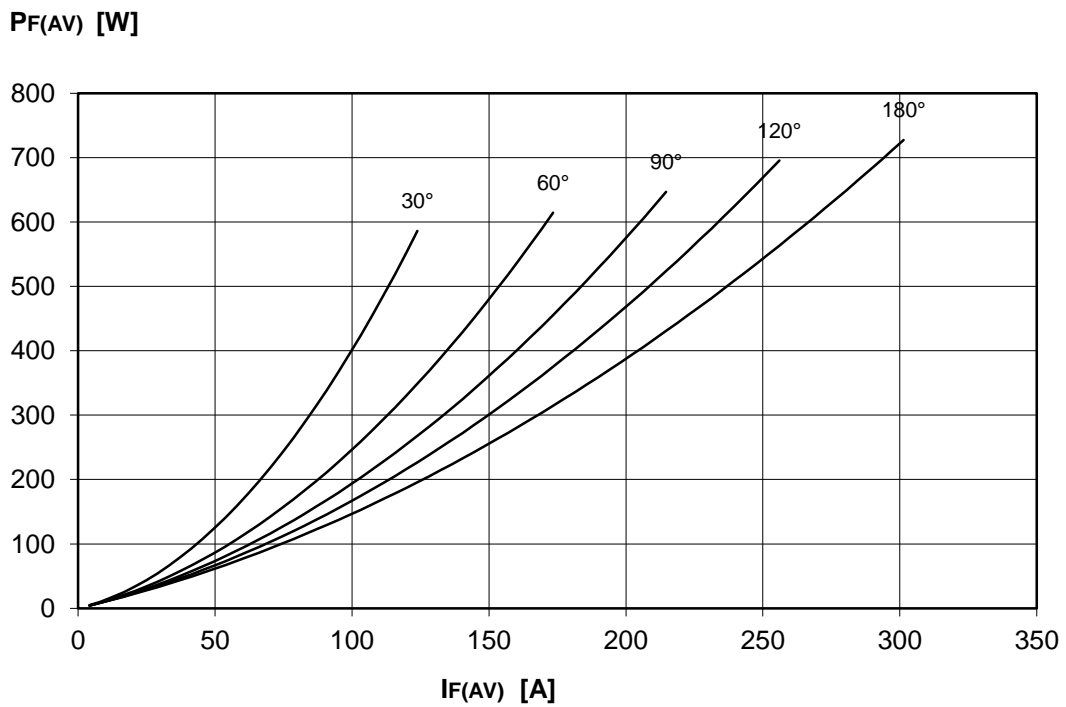
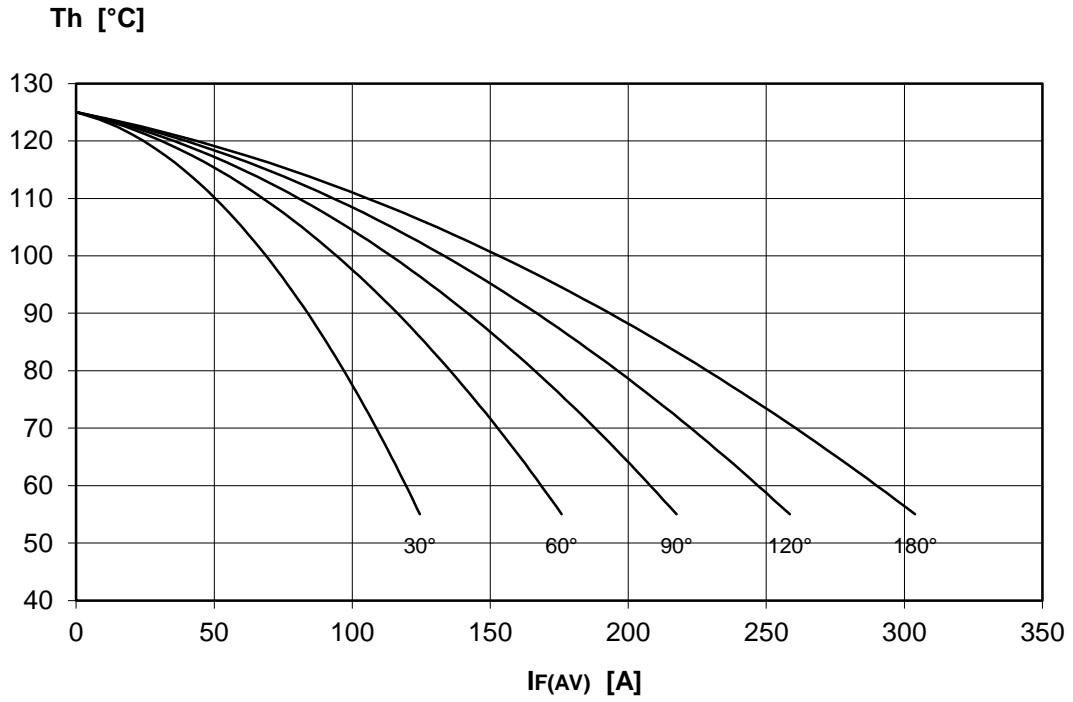

# AT405 PHASE CONTROL THYRISTOR



FINAL SPECIFICATION Feb. 17 - Issue: 6

ON-STATE CHARACTERISTIC  
T<sub>j</sub> = 125 °C

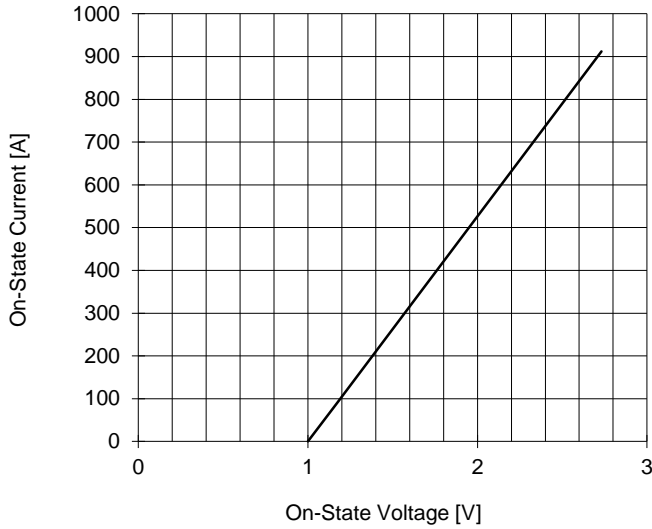

SURGE CHARACTERISTIC  
T<sub>j</sub> = 125 °C

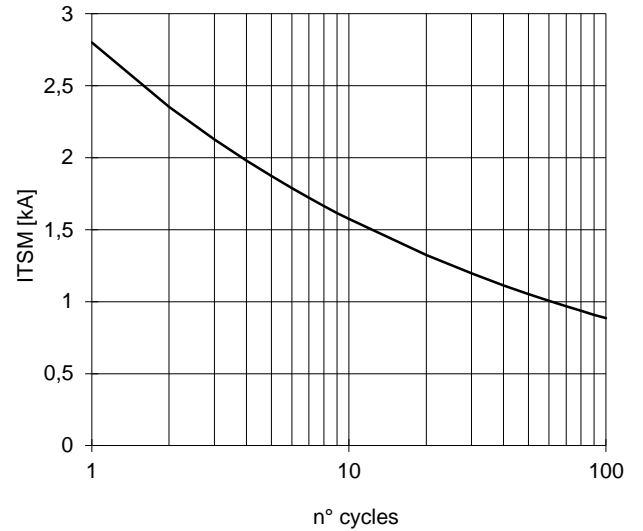

TRANSIENT THERMAL IMPEDANCE  
DOUBLE SIDE COOLED

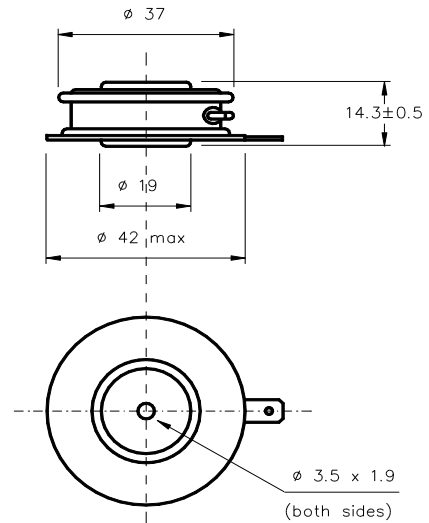
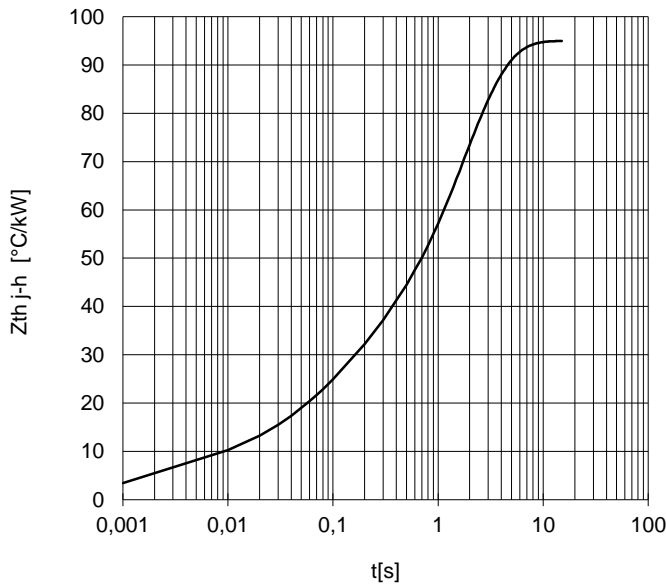

Dimensions  
in mm



Cathode terminal type DIN 46244 - A 4.8 - 0.8

Gate terminal type AMP 60598 - 1

Distributed by

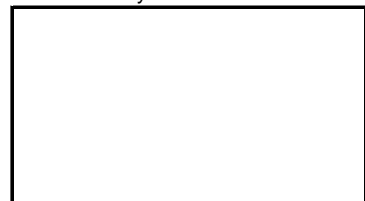

All the characteristics given in this data sheet are guaranteed only with uniform clamping force, cleaned and lubricated heatsink, surfaces with flatness < .03 mm and roughness < 2 μm. In the interest of product improvement POSEICO SpA reserves the right to change any data given in this data sheet at any time without previous notice. If not stated otherwise the maximum value of ratings (symbols over shaded background) and characteristics is reported.