



**SEMITRANS® 3**

## IGBT4 Modules

### SKM300GAL12E4

#### Features

- IGBT4 = 4. generation medium fast trench IGBT (Infineon)
- CAL4 = Soft switching 4. generation CAL-diode
- Isolated copper baseplate using DBC technology (Direct Bonded Copper)
- Increased power cycling capability
- With integrated gate resistor
- For higher switching frequencies up to 12kHz
- UL recognized, file no. E63532

#### Typical Applications\*

- DC/DC – converter
- Brake chopper
- Switched reluctance motor

#### Remarks

- Case temperature limited to  $T_c = 125^\circ\text{C}$  max.
- Recommended  $T_{op} = -40 \dots +150^\circ\text{C}$
- Product reliability results valid for  $T_j = 150^\circ\text{C}$

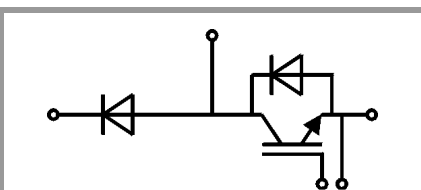

**GAL**

#### Absolute Maximum Ratings

| Symbol                    | Conditions   | Values                    | Unit             |               |
|---------------------------|--|---------------------------|------------------|---------------|
| <b>IGBT</b>               |  |                           |                  |               |
| $V_{CES}$                 | $T_j = 25^\circ\text{C}$   | 1200                      | V                |               |
| $I_C$                     | $T_j = 175^\circ\text{C}$  | $T_c = 25^\circ\text{C}$  | 422              | A             |
|                           |  | $T_c = 80^\circ\text{C}$  | 324              | A             |
| $I_{Cnom}$                |  | 300                       | A                |               |
| $I_{CRM}$                 | $I_{CRM} = 3 \times I_{Cnom}$  | 900                       | A                |               |
| $V_{GES}$                 |  | -20 ... 20                | V                |               |
| $t_{psc}$                 | $V_{CC} = 800\text{ V}$<br>$V_{GE} \leq 15\text{ V}$<br>$V_{CES} \leq 1200\text{ V}$ | $T_j = 150^\circ\text{C}$ | 10               | $\mu\text{s}$ |
|                           |  |                           |                  |               |
| $T_j$                     |  | -40 ... 175               | $^\circ\text{C}$ |               |
| <b>Inverse diode</b>      |  |                           |                  |               |
| $I_F$                     | $T_j = 175^\circ\text{C}$  | $T_c = 25^\circ\text{C}$  | 353              | A             |
|                           |  | $T_c = 80^\circ\text{C}$  | 264              | A             |
| $I_{Fnom}$                |  | 300                       | A                |               |
| $I_{FRM}$                 | $I_{FRM} = 3 \times I_{Fnom}$  | 900                       | A                |               |
| $I_{FSM}$                 | $t_p = 10\text{ ms, sin } 180^\circ, T_j = 25^\circ\text{C}$                         | 1548                      | A                |               |
| $T_j$                     |  | -40 ... 175               | $^\circ\text{C}$ |               |
| <b>Freewheeling diode</b> |  |                           |                  |               |
| $I_F$                     | $T_j = 175^\circ\text{C}$  | $T_c = 25^\circ\text{C}$  | 353              | A             |
|                           |  | $T_c = 80^\circ\text{C}$  | 264              | A             |
| $I_{Fnom}$                |  | 300                       | A                |               |
| $I_{FRM}$                 | $I_{FRM} = 3 \times I_{Fnom}$  | 900                       | A                |               |
| $I_{FSM}$                 | $t_p = 10\text{ ms, sin } 180^\circ, T_j = 25^\circ\text{C}$                         | 1548                      | A                |               |
| $T_j$                     |  | -40 ... 175               | $^\circ\text{C}$ |               |
| <b>Module</b>             |  |                           |                  |               |
| $I_{t(RMS)}$              | $T_{terminal} = 80^\circ\text{C}$  | 500                       | A                |               |
| $T_{stg}$                 |  | -40 ... 125               | $^\circ\text{C}$ |               |
| $V_{isol}$                | AC sinus 50 Hz, $t = 1\text{ min}$   | 4000                      | V                |               |

#### Characteristics

| Symbol        | Conditions  | min.                      | typ. | max. | Unit             |
|---------------|---|---------------------------|------|------|------------------|
| <b>IGBT</b>   |   |                           |      |      |                  |
| $V_{CE(sat)}$ | $I_C = 300\text{ A}$<br>$V_{GE} = 15\text{ V}$<br>chiplevel | $T_j = 25^\circ\text{C}$  | 1.85 | 2.10 | V                |
|               |   | $T_j = 150^\circ\text{C}$ | 2.25 | 2.45 | V                |
| $V_{CE0}$     | chiplevel   | $T_j = 25^\circ\text{C}$  | 0.8  | 0.9  | V                |
|               |   | $T_j = 150^\circ\text{C}$ | 0.7  | 0.8  | V                |
| $r_{CE}$      | $V_{GE} = 15\text{ V}$<br>chiplevel                         | $T_j = 25^\circ\text{C}$  | 3.50 | 4.00 | $\text{m}\Omega$ |
|               |   | $T_j = 150^\circ\text{C}$ | 5.17 | 5.50 | $\text{m}\Omega$ |
| $V_{GE(th)}$  | $V_{GE} = V_{CE}, I_C = 12\text{ mA}$                       | 5                         | 5.8  | 6.5  | V                |
| $I_{CES}$     | $V_{GE} = 0\text{ V}$<br>$V_{CE} = 1200\text{ V}$           | $T_j = 25^\circ\text{C}$  |      | 4.0  | $\text{mA}$      |
|               |   | $T_j = 150^\circ\text{C}$ |      |      | $\text{mA}$      |
| $C_{ies}$     | $V_{CE} = 25\text{ V}$                                      |                           | 17.6 |      | nF               |
| $C_{oes}$     | $V_{GE} = 0\text{ V}$                                       |                           | 1.16 |      | nF               |
| $C_{res}$     |   |                           | 0.94 |      | nF               |
| $Q_G$         | $V_{GE} = -8\text{ V} \dots +15\text{ V}$                   |                           | 1700 |      | nC               |
| $R_{Gint}$    | $T_j = 25^\circ\text{C}$                                    |                           | 2.5  |      | $\Omega$         |



**SEMITRANS® 3**

## IGBT4 Modules

### SKM300GAL12E4

#### Features

- IGBT4 = 4. generation medium fast trench IGBT (Infineon)
- CAL4 = Soft switching 4. generation CAL-diode
- Isolated copper baseplate using DBC technology (Direct Bonded Copper)
- Increased power cycling capability
- With integrated gate resistor
- For higher switching frequencies up to 12kHz
- UL recognized, file no. E63532

#### Typical Applications\*

- DC/DC – converter
- Brake chopper
- Switched reluctance motor

#### Remarks

- Case temperature limited to  $T_c = 125^\circ\text{C}$  max.
- Recommended  $T_{op} = -40 \dots +150^\circ\text{C}$
- Product reliability results valid for  $T_j = 150^\circ\text{C}$

| Characteristics    |   |                           |      |      |       |               |
|--------------------|---|---------------------------|------|------|-------|---------------|
| Symbol             | Conditions                                |                           | min. | typ. | max.  | Unit          |
| $t_{d(on)}$        | $V_{CC} = 600\text{ V}$                   | $T_j = 150^\circ\text{C}$ |      | 220  |       | ns            |
| $t_r$              | $I_C = 300\text{ A}$                      | $T_j = 150^\circ\text{C}$ |      | 44   |       | ns            |
| $E_{on}$           | $V_{GE} = \pm 15\text{ V}$                | $T_j = 150^\circ\text{C}$ |      | 27   |       | mJ            |
|                    | $R_{G\ on} = 1.5\ \Omega$                 |                           |      |      |       |               |
| $t_{d(off)}$       | $R_{G\ off} = 1.5\ \Omega$                | $T_j = 150^\circ\text{C}$ |      | 520  |       | ns            |
| $t_f$              | $di/dt_{on} = 6100\text{ A}/\mu\text{s}$  | $T_j = 150^\circ\text{C}$ |      | 117  |       | ns            |
|                    | $di/dt_{off} = 3000\text{ A}/\mu\text{s}$ |                           |      |      |       |               |
| $E_{off}$          |   | $T_j = 150^\circ\text{C}$ |      | 39   |       | mJ            |
| $R_{th(j-c)}$      | per IGBT                                  |                           |      |      | 0.11  | K/W           |
| Inverse diode      |   |                           |      |      |       |               |
| $V_F = V_{EC}$     | $I_F = 300\text{ A}$                      | $T_j = 25^\circ\text{C}$  |      | 2.17 | 2.49  | V             |
|                    | $V_{GE} = 0\text{ V}$                     | $T_j = 150^\circ\text{C}$ |      | 2.11 | 2.42  | V             |
|                    | chipllevel                                |                           |      |      |       |               |
| $V_{F0}$           |   | $T_j = 25^\circ\text{C}$  |      | 1.3  | 1.5   | V             |
|                    | chipllevel                                | $T_j = 150^\circ\text{C}$ |      | 0.9  | 1.1   | V             |
| $r_F$              |   | $T_j = 25^\circ\text{C}$  |      | 2.9  | 3.3   | m $\Omega$    |
|                    | chipllevel                                | $T_j = 150^\circ\text{C}$ |      | 4.0  | 4.4   | m $\Omega$    |
| $I_{RRM}$          | $I_F = 300\text{ A}$                      | $T_j = 150^\circ\text{C}$ |      | 345  |       | A             |
| $Q_{rr}$           | $di/dt_{off} = 7300\text{ A}/\mu\text{s}$ | $T_j = 150^\circ\text{C}$ |      | 54   |       | $\mu\text{C}$ |
| $E_{rr}$           | $V_{GE} = \pm 15\text{ V}$                | $T_j = 150^\circ\text{C}$ |      | 23   |       | mJ            |
|                    | $V_{CC} = 600\text{ V}$                   |                           |      |      |       |               |
| $R_{th(j-c)}$      | per diode                                 |                           |      |      | 0.17  | K/W           |
| Freewheeling diode |   |                           |      |      |       |               |
| $V_F = V_{EC}$     | $I_F = 300\text{ A}$                      | $T_j = 25^\circ\text{C}$  |      | 2.17 | 2.49  | V             |
|                    | $V_{GE} = 0\text{ V}$                     | $T_j = 150^\circ\text{C}$ |      | 2.11 | 2.42  | V             |
|                    | chipllevel                                |                           |      |      |       |               |
| $V_{F0}$           |   | $T_j = 25^\circ\text{C}$  |      | 1.3  | 1.5   | V             |
|                    | chipllevel                                | $T_j = 150^\circ\text{C}$ |      | 0.9  | 1.1   | V             |
| $r_F$              |   | $T_j = 25^\circ\text{C}$  |      | 2.9  | 3.3   | m $\Omega$    |
|                    | chipllevel                                | $T_j = 150^\circ\text{C}$ |      | 4.0  | 4.4   | m $\Omega$    |
| $I_{RRM}$          | $I_F = 300\text{ A}$                      | $T_j = 150^\circ\text{C}$ |      | 345  |       | A             |
| $Q_{rr}$           | $di/dt_{off} = 7300\text{ A}/\mu\text{s}$ | $T_j = 150^\circ\text{C}$ |      | 54   |       | $\mu\text{C}$ |
| $E_{rr}$           | $V_{GE} = \pm 15\text{ V}$                | $T_j = 150^\circ\text{C}$ |      | 23   |       | mJ            |
|                    | $V_{CC} = 600\text{ V}$                   |                           |      |      |       |               |
| $R_{th(j-c)}$      | per Diode                                 |                           |      |      | 0.17  | K/W           |
| Module             |   |                           |      |      |       |               |
| $L_{CE}$           |   |                           |      | 15   | 20    | nH            |
| $R_{CC+EE}$        | terminal-chip                             | $T_C = 25^\circ\text{C}$  |      | 0.25 |       | m $\Omega$    |
|                    |   | $T_C = 125^\circ\text{C}$ |      | 0.5  |       | m $\Omega$    |
| $R_{th(c-s)}$      | per module                                |                           |      | 0.02 | 0.038 | K/W           |
| $M_s$              | to heat sink M6                           |                           |      | 3    | 5     | Nm            |
| $M_t$              |   | to terminals M6           |      | 2.5  | 5     | Nm            |
|                    |   |                           |      |      |       | Nm            |
| $w$                |   |                           |      |      | 325   | g             |

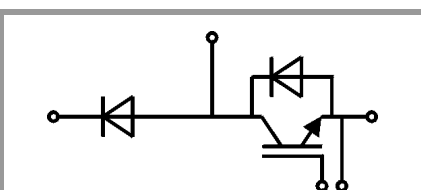

**GAL**

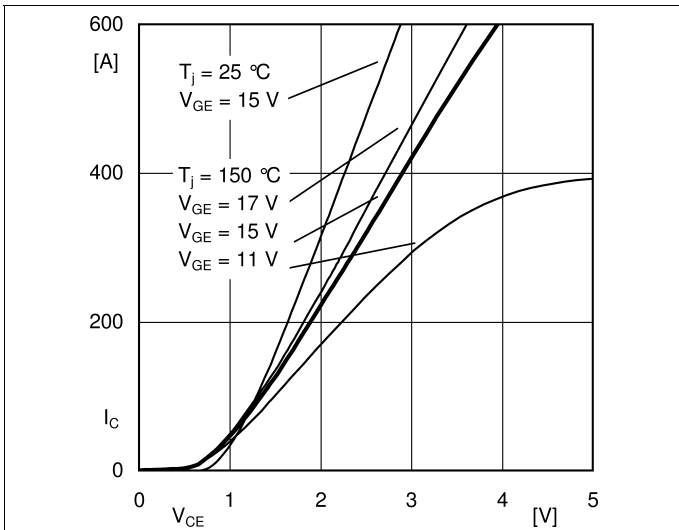

Fig. 1: Typ. output characteristic, inclusive  $R_{CC'+EE'}$

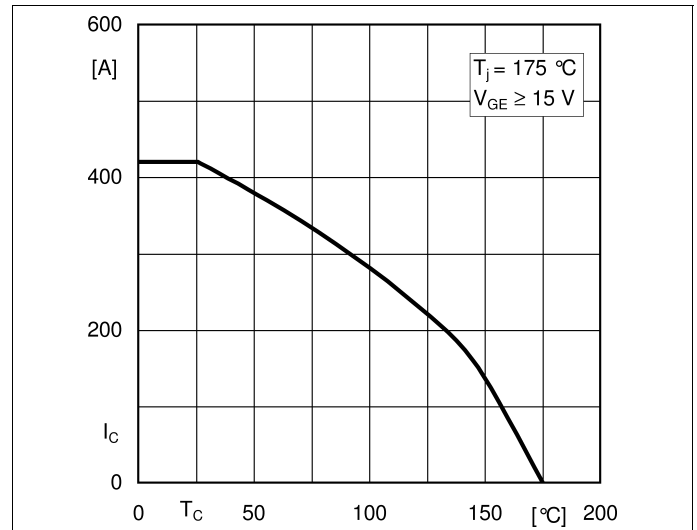

Fig. 2: Rated current vs. temperature  $I_C = f(T_C)$

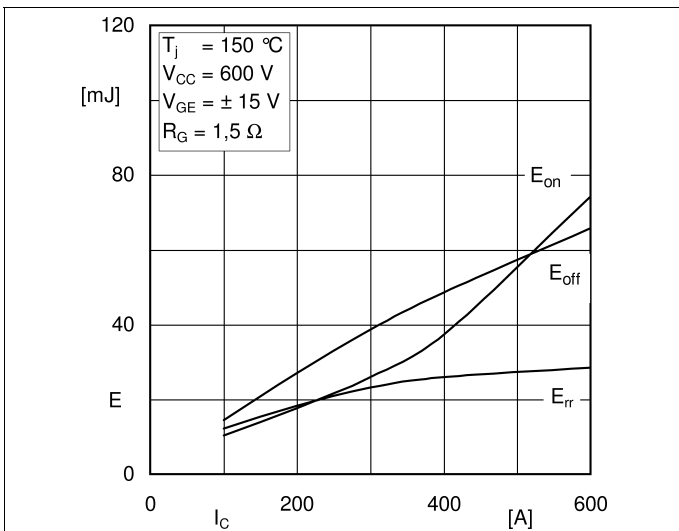

Fig. 3: Typ. turn-on /-off energy =  $f(I_C)$

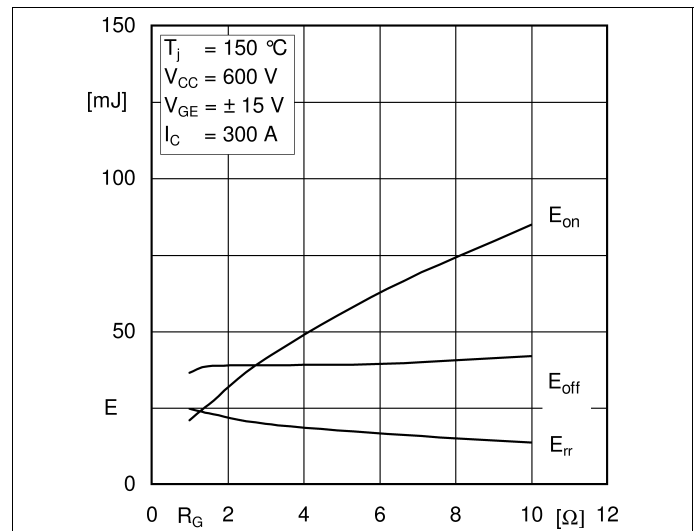

Fig. 4: Typ. turn-on /-off energy =  $f(R_G)$

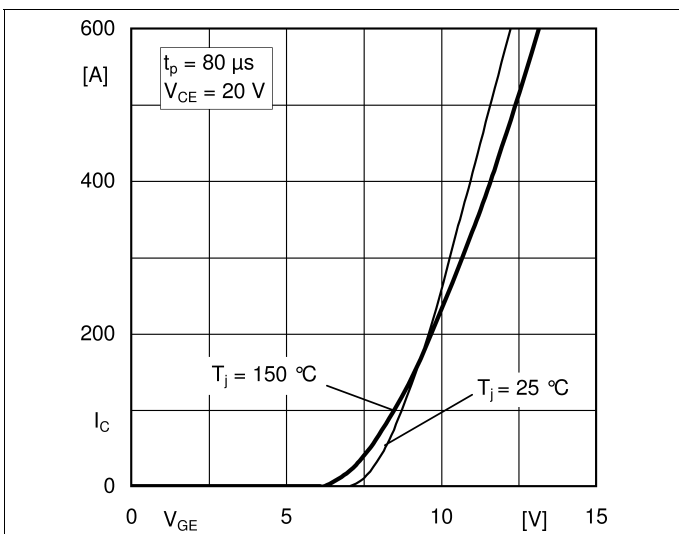

Fig. 5: Typ. transfer characteristic

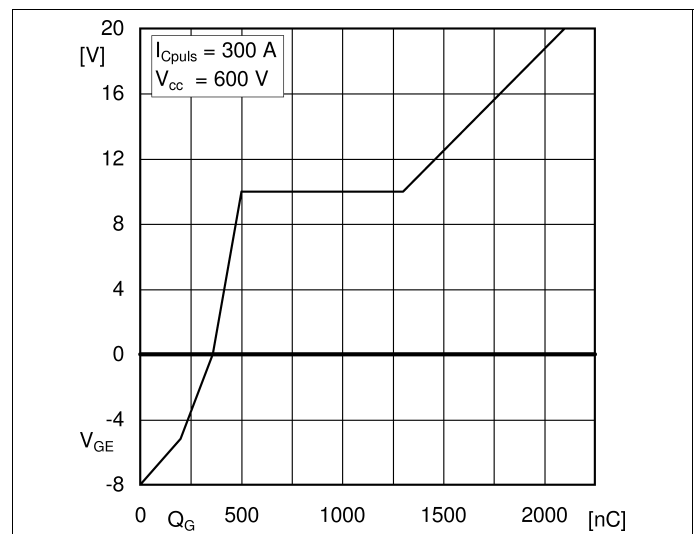

Fig. 6: Typ. gate charge characteristic

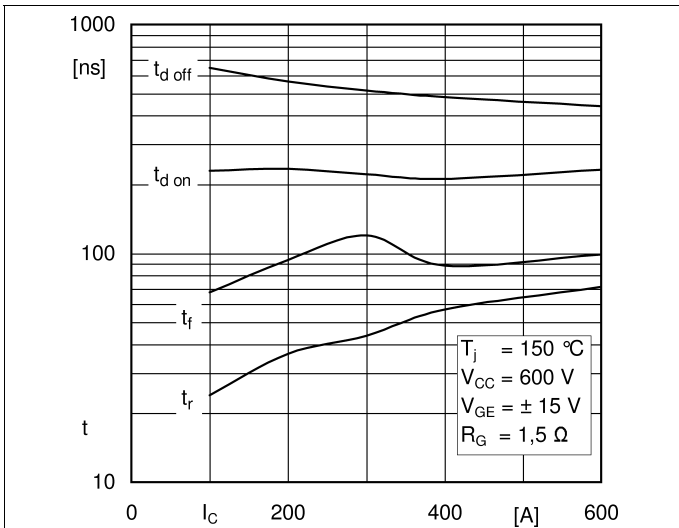

Fig. 7: Typ. switching times vs.  $I_C$

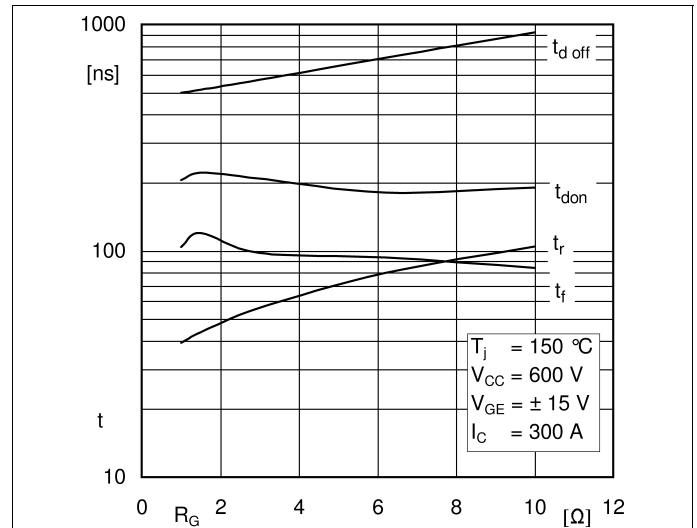

Fig. 8: Typ. switching times vs. gate resistor  $R_G$

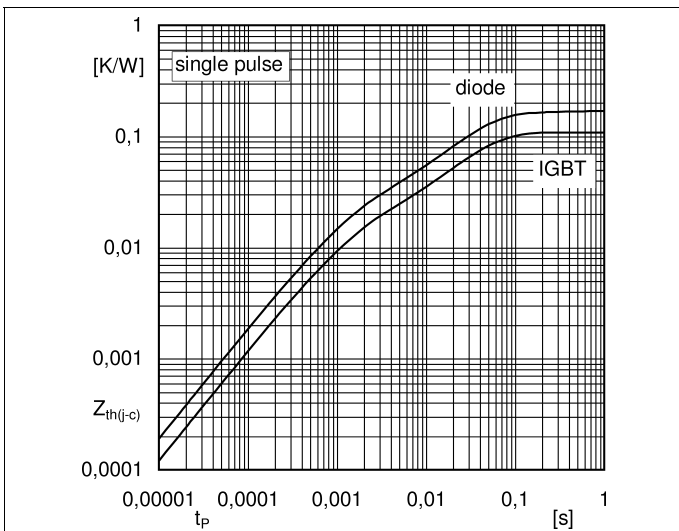

Fig. 9: Transient thermal impedance

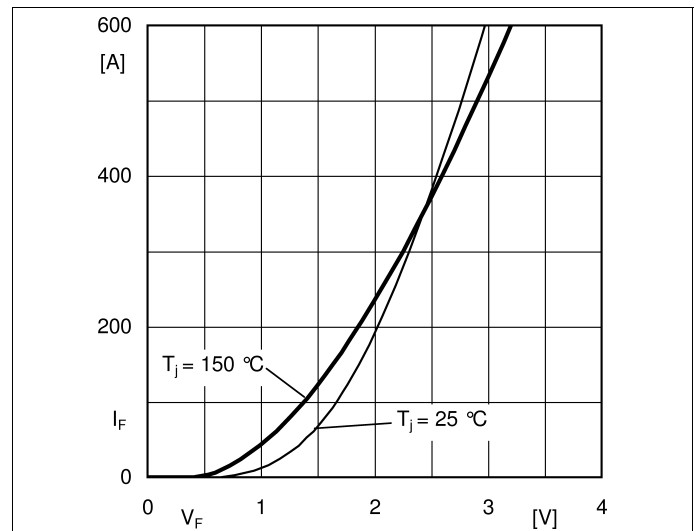

Fig. 10: Typ. CAL diode forward charact., incl.  $R_{CC+EE'}$

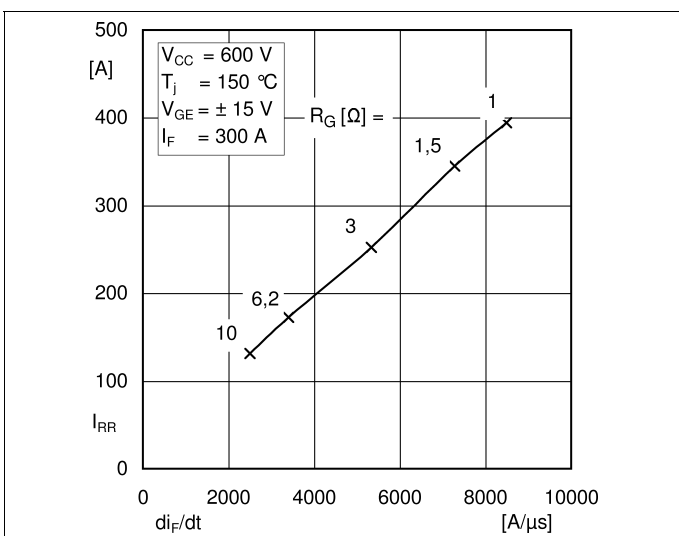

Fig. 11: CAL diode peak reverse recovery current

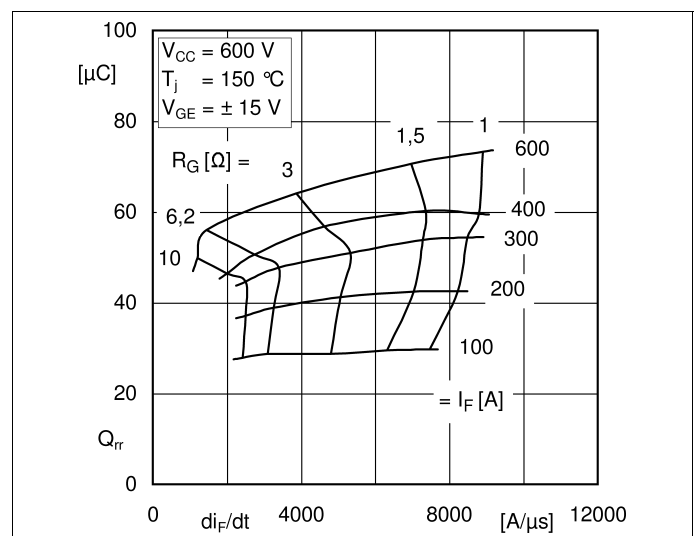
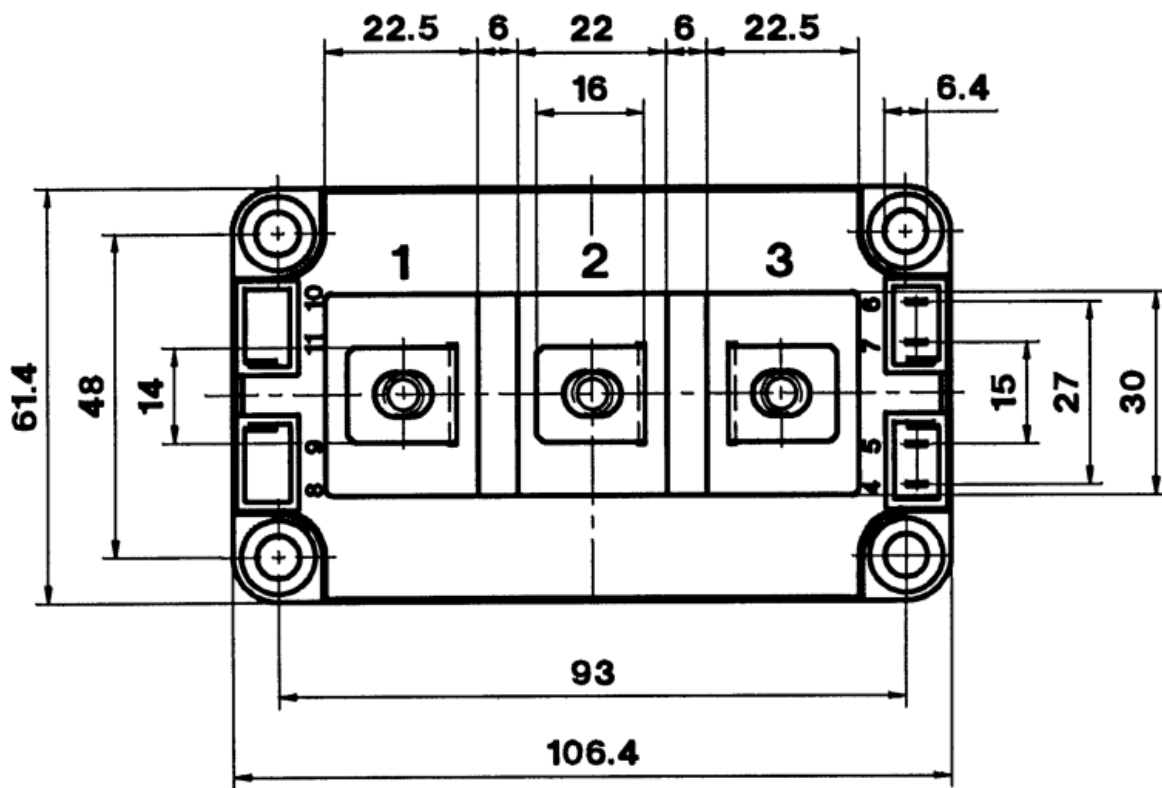
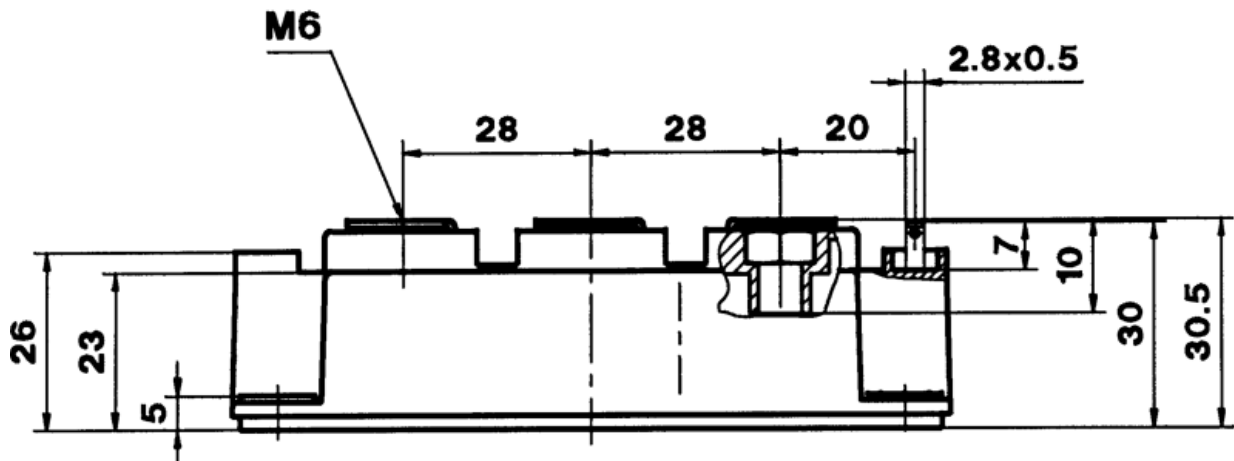
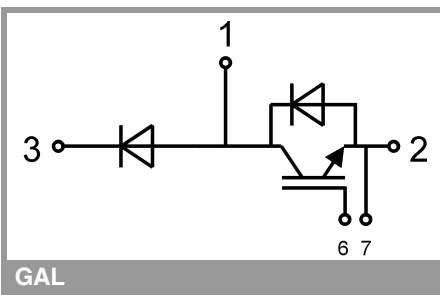

Fig. 12: Typ. CAL diode peak reverse recovery charge



SEMITRANS 3



GAL

This is an electrostatic discharge sensitive device (ESDS), international standard IEC 60747-1, Chapter IX

\* The specifications of our components may not be considered as an assurance of component characteristics. Components have to be tested for the respective application. Adjustments may be necessary. The use of SEMIKRON products in life support appliances and systems is subject to prior specification and written approval by SEMIKRON. We therefore strongly recommend prior consultation of our staff.