

SEMITOP® 3

IGBT Module

SK50MLI066

Target Data

Features

- Compact design
- One screw mounting
- Heat transfer and isolation through direct copper bonded aluminium oxide ceramic (DCB)
- Trench IGBT technology
- CAL technology FWD

Typical Applications*

- 3 Level Inverter
- UPS

Remarks

- Visol = 3000V AC, 1s, 50Hz
- Dynamic measure: DUT= IGBT (Gate pin 1) and Neutral Clamp Diode (Kathode pin 16) as free-wheeling diode



MLI

Absolute Maximum Ratings		$T_s = 25\text{ °C}$, unless otherwise specified		
Symbol	Conditions	Values		Units
IGBT				
V_{CES}	$T_j = 25\text{ °C}$	600		V
I_C	$T_j = 175\text{ °C}$	$T_s = 25\text{ °C}$	60	A
		$T_s = 70\text{ °C}$	50	A
I_{CRM}	$I_{CRM} = 2 \times I_{Cnom}$	100		A
V_{GES}		± 20		V
t_{psc}	$V_{CC} = 360\text{ V}$; $V_{GE} \leq 20\text{ V}$; $T_j = 150\text{ °C}$ $V_{CES} < 600\text{ V}$	6		µs
Inverse Diode				
I_F	$T_j = 175\text{ °C}$	$T_s = 25\text{ °C}$	56	A
		$T_s = 70\text{ °C}$	44	A
I_{FRM}	$I_{FRM} = 2 \times I_{Fnom}$	100		A
I_{FSM}	$t_p = 10\text{ ms}$; half sine wave $T_j = 150\text{ °C}$	320		A
Freewheeling Diode				
I_F	$T_j = 175\text{ °C}$	$T_s = 25\text{ °C}$	56	A
		$T_s = 70\text{ °C}$	44	A
I_{FRM}	$I_{FRM} = 2 \times I_{Fnom}$	60		A
I_{FSM}	$t_p = 10\text{ ms}$; half sine wave $T_j = 150\text{ °C}$	320		A
Module				
$I_{t(RMS)}$				A
T_{vj}		-40 ... +175		°C
T_{stg}		-40 ... +125		°C
V_{isol}	AC, 1 min.	2500		V

Characteristics		$T_s = 25\text{ °C}$, unless otherwise specified			
Symbol	Conditions	min.	typ.	max.	Units
IGBT					
$V_{GE(th)}$	$V_{GE} = V_{CE}$, $I_C = 0,8\text{ mA}$	5	5,8	6,5	V
I_{CES}	$V_{GE} = 0\text{ V}$, $V_{CE} = V_{CES}$ $T_j = 25\text{ °C}$			0,0026	mA
I_{GES}	$V_{CE} = 0\text{ V}$, $V_{GE} = 20\text{ V}$ $T_j = 25\text{ °C}$			600	nA
V_{CE0}		$T_j = 25\text{ °C}$	0,9	1,1	V
		$T_j = 150\text{ °C}$	0,8	1	V
r_{CE}	$V_{GE} = 15\text{ V}$	$T_j = 25\text{ °C}$	11		mΩ
		$T_j = 150\text{ °C}$	17		mΩ
$V_{CE(sat)}$	$I_{Cnom} = 50\text{ A}$, $V_{GE} = 15\text{ V}$	$T_j = 25\text{ °C}_{chiplev.}$	1,45		V
		$T_j = 150\text{ °C}_{chiplev.}$	1,65		V
C_{ies}	$V_{CE} = 25$, $V_{GE} = 0\text{ V}$ $f = 1\text{ MHz}$	3,1		nF	
C_{oes}		0,2		nF	
C_{res}		0,093		nF	
$t_{d(on)}$	$R_{Gon} = 16\text{ }\Omega$	$V_{CC} = 300\text{ V}$ $I_C = 50\text{ A}$	30		ns
t_r			31		ns
E_{on}	$R_{Goff} = 16\text{ }\Omega$	$T_j = 150\text{ °C}$ $V_{GE} = -7/+15\text{ V}$	1,46		mJ
$t_{d(off)}$			351		ns
t_f			45		ns
E_{off}	per IGBT		2,02		mJ
$R_{th(j-s)}$			1,11		K/W

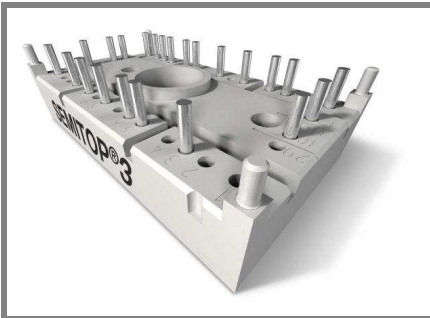

SEMITOP® 3

IGBT Module

SK50MLI066

Target Data

Features

- Compact design
- One screw mounting
- Heat transfer and isolation through direct copper bonded aluminium oxide ceramic (DCB)
- Trench IGBT technology
- CAL technology FWD

Typical Applications*

- 3 Level Inverter
- UPS

Remarks

- Visol = 3000V AC, 1s, 50Hz
- Dynamic measure: DUT= IGBT (Gate pin 1) and Neutral Clamp Diode (Kathode pin 16) as free-wheeling diode

Characteristics

Symbol	Conditions	min.	typ.	max.	Units
Inverse Diode (Antiparallel Diode)					
$V_F = V_{EC}$	$I_{Fnom} = 50 \text{ A}; V_{GE} = 0 \text{ V}$		$T_j = 25 \text{ }^\circ\text{C}_{chiplev.}$	1,5	V
			$T_j = 150 \text{ }^\circ\text{C}_{chiplev.}$	1,5	V
V_{F0}			$T_j = 25 \text{ }^\circ\text{C}$	1	V
			$T_j = 150 \text{ }^\circ\text{C}$	0,9	V
r_F			$T_j = 25 \text{ }^\circ\text{C}$	10	mΩ
			$T_j = 150 \text{ }^\circ\text{C}$	12	mΩ
I_{RRM}	$I_F = 50 \text{ A}$		$T_j = 150 \text{ }^\circ\text{C}$		A
Q_{rr}					μC
E_{rr}	$V_R = 300 \text{ V}$			1,07	mJ
$R_{th(j-s)D}$	per diode			1,7	K/W
Freewheeling Diode (Neutral Clamp diode)					
$V_F = V_{EC}$	$I_{Fnom} = 50 \text{ A}; V_{GE} = 0 \text{ V}$		$T_j = 25 \text{ }^\circ\text{C}_{chiplev.}$	1,5	V
			$T_j = 150 \text{ }^\circ\text{C}_{chiplev.}$	1,5	V
V_{F0}			$T_j = 25 \text{ }^\circ\text{C}$	1	V
			$T_j = 150 \text{ }^\circ\text{C}$	0,9	V
r_F			$T_j = 25 \text{ }^\circ\text{C}$	10	V
			$T_j = 150 \text{ }^\circ\text{C}$	12	V
I_{RRM}	$I_F = 50 \text{ A}$		$T_j = 150 \text{ }^\circ\text{C}$	40	A
Q_{rr}	$di/dt = -2670 \text{ A}/\mu\text{s}$			2,2	μC
E_{rr}	$V_R = 300 \text{ V}$			1,07	mJ
$R_{th(j-s)FD}$	per diode			1,7	K/W
M_s	to heat sink	2,25		2,5	Nm
w				30	g

This is an electrostatic discharge sensitive device (ESDS), international standard IEC 60747-1, Chapter IX.

* The specifications of our components may not be considered as an assurance of component characteristics. Components have to be tested for the respective application. Adjustments may be necessary. The use of SEMIKRON products in life support appliances and systems is subject to prior specification and written approval by SEMIKRON. We therefore strongly recommend prior consultation of our personal.



MLI

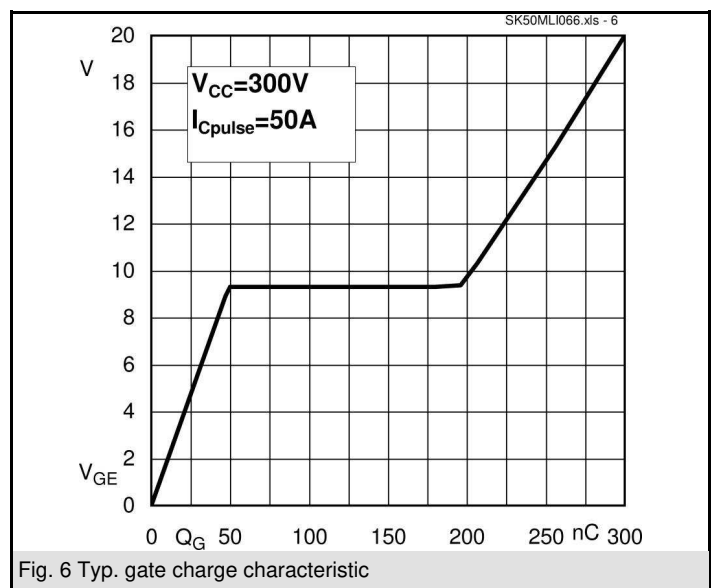
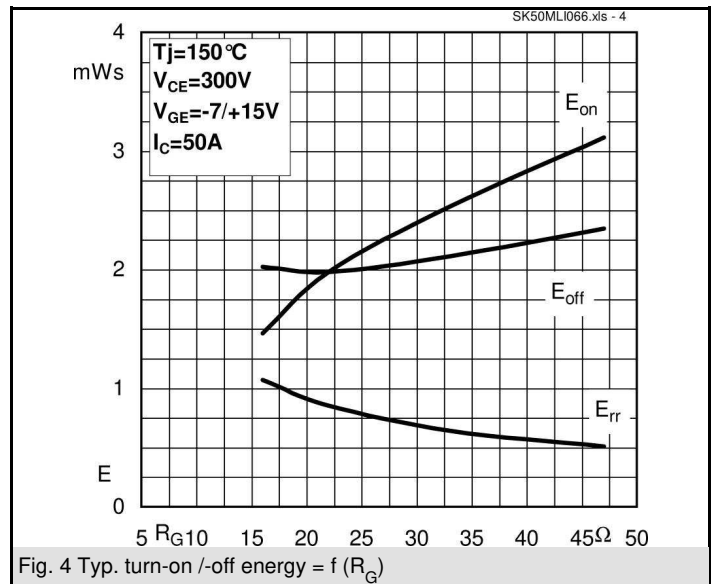
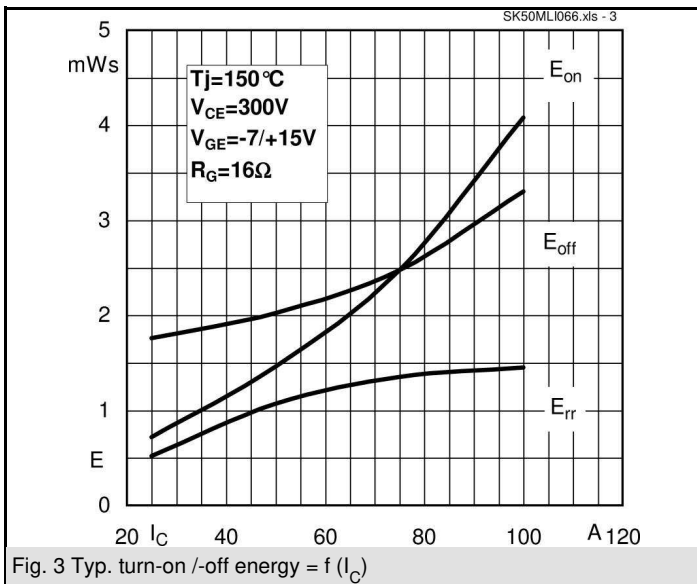
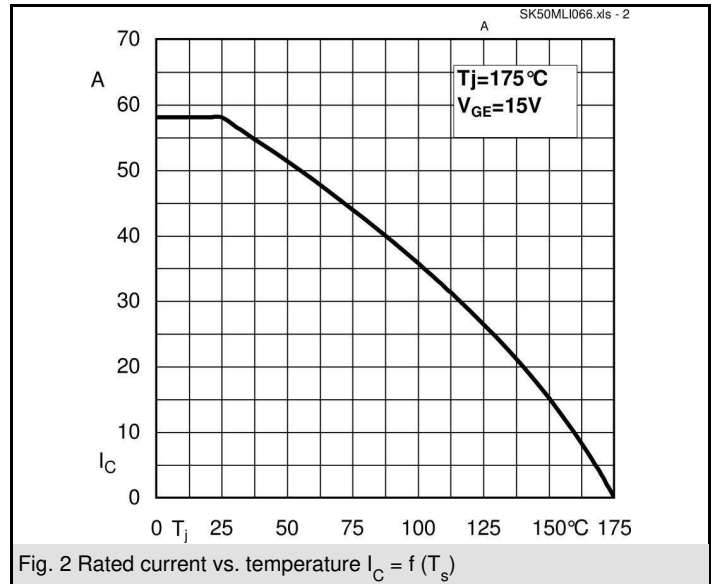
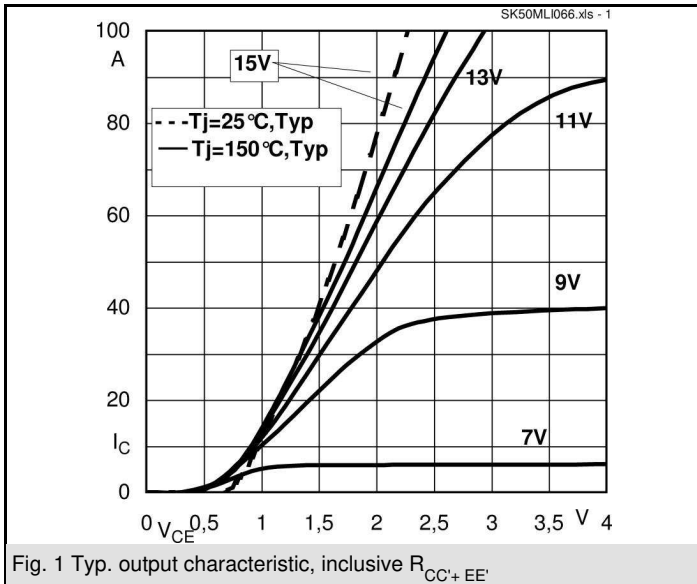

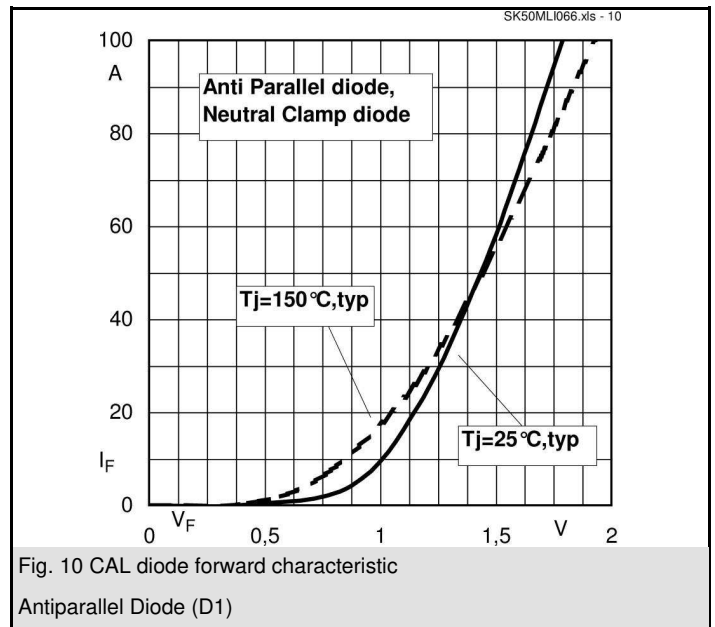
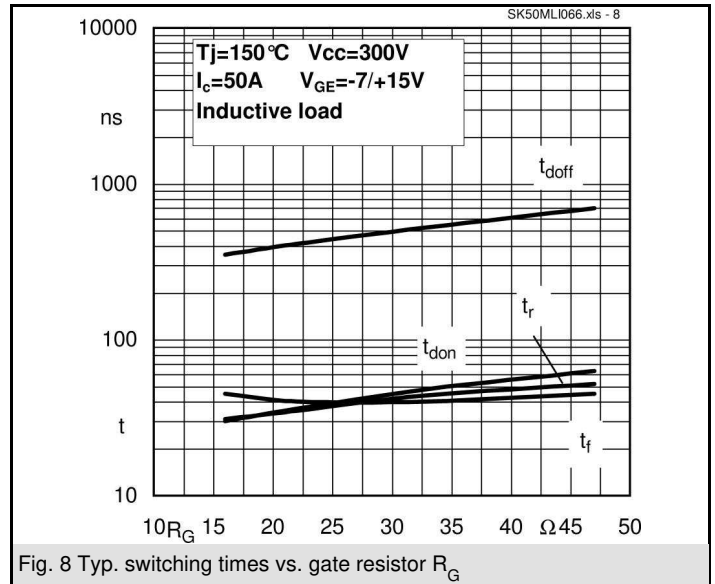
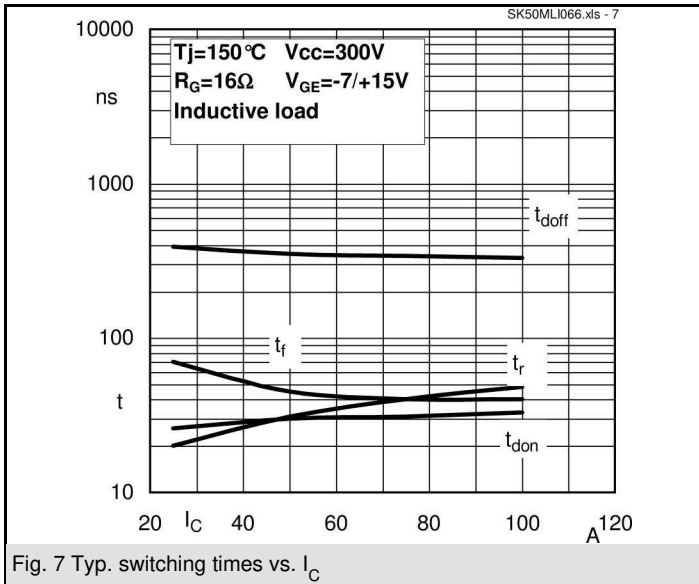

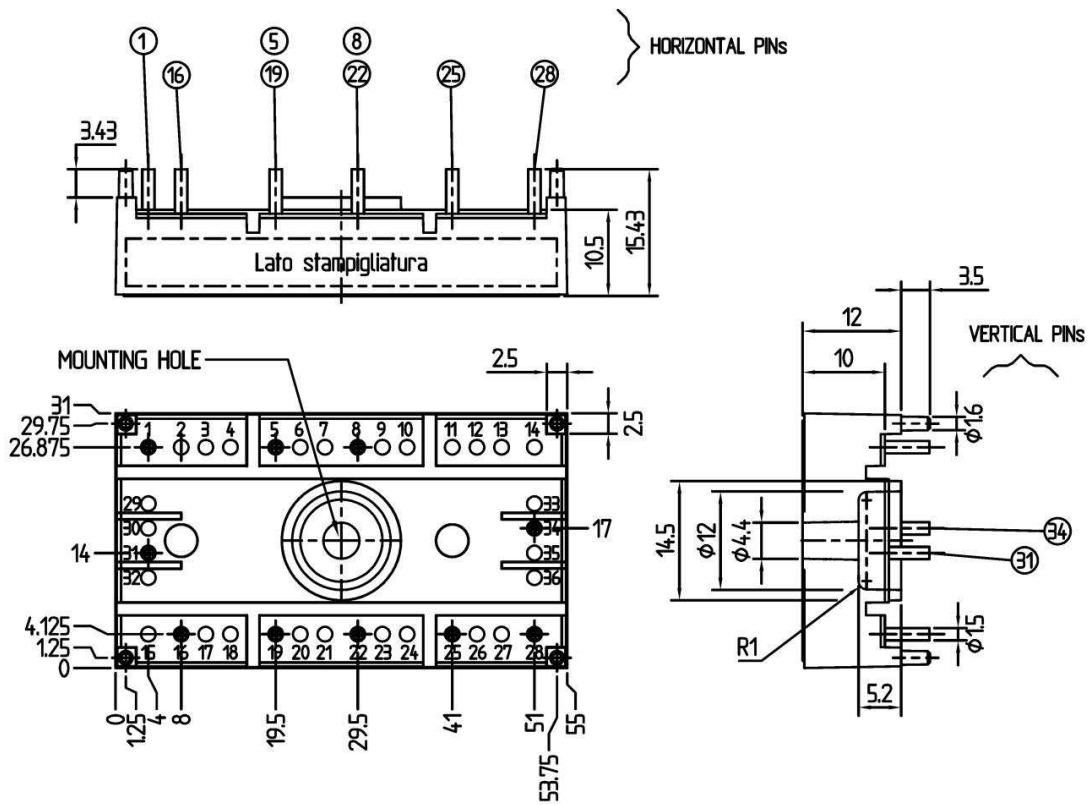

Case T 76 (Suggested hole diameter, in the PCB, for solder pins and plastic mounting pins: 2mm)

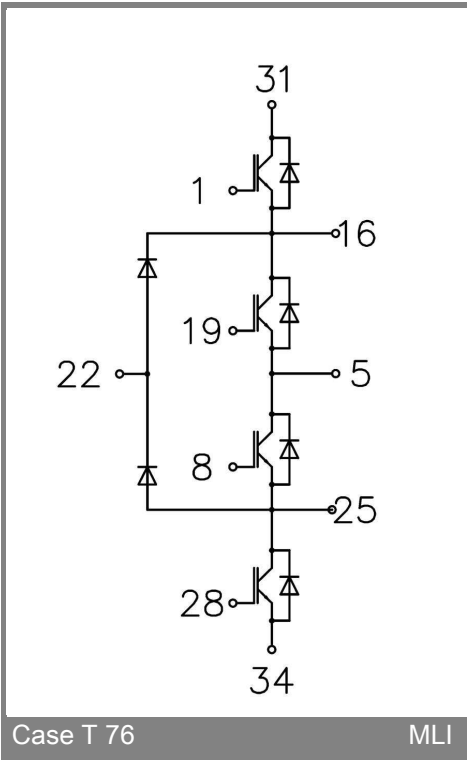

Case T 76

MLI