

**SEMITOP® 3**

## IGBT Module

**SK60GB125**

Preliminary Data

### Features

- Compact design
- One screw mounting
- Heat transfer and isolation through direct copper bonded aluminium oxide ceramic (DCB)
- High short circuit capability
- Ultra Fast NPT IGBT technology
- $V_{ce,sat}$  with positive coefficient

### Typical Applications\*

- Switching (not for linear use)
- Inverter
- Switched mode power supplies
- UPS

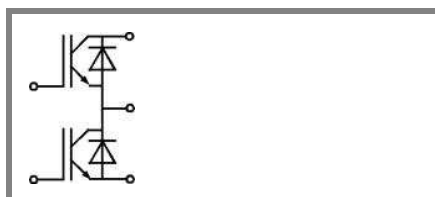

**GB**

Absolute Maximum Ratings		$T_s = 25\text{ °C}$ , unless otherwise specified			
Symbol	Conditions	Values			Units
<b>IGBT</b>					
$V_{CES}$	$T_j = 25\text{ °C}$	1200			V
$I_C$	$T_j = 125\text{ °C}$	$T_s = 25\text{ °C}$	51		A
		$T_s = 80\text{ °C}$	35		A
$I_{CRM}$	$I_{CRM} = 2 \times I_{Cnom}$	100			A
$V_{GES}$		$\pm 20$			V
$t_{psc}$	$V_{CC} = 300\text{ V}; V_{GE} \leq 20\text{ V}; T_j = 125\text{ °C}$ $V_{CES} < 600\text{ V}$	10			$\mu\text{s}$
<b>Inverse Diode</b>					
$I_F$	$T_j = 150\text{ °C}$	$T_s = 25\text{ °C}$	57		A
		$T_s = 80\text{ °C}$	38		A
$I_{FRM}$	$I_{FRM} = 2 \times I_{Fnom}$				A
$I_{FSM}$	$t_p = 10\text{ ms}; \text{half sine wave } T_j = 150\text{ °C}$	550			A
<b>Module</b>					
$I_{t(RMS)}$					A
$T_{vj}$		-40 ... +150			$^{\circ}\text{C}$
$T_{stg}$		-40 ... +125			$^{\circ}\text{C}$
$V_{isol}$	AC, 1 min.	2500			V

Characteristics		$T_s = 25\text{ °C}$ , unless otherwise specified			
Symbol	Conditions	min.	typ.	max.	Units
<b>IGBT</b>					
$V_{GE(th)}$	$V_{GE} = V_{CE}, I_C = 2\text{ mA}$	4,5	5,5	6,5	V
$I_{CES}$	$V_{GE} = 0\text{ V}, V_{CE} = V_{CES} \quad T_j = 25\text{ °C}$	0,006			mA
$I_{GES}$	$V_{CE} = 0\text{ V}, V_{GE} = 20\text{ V} \quad T_j = 25\text{ °C}$	300			nA
$V_{CE0}$		$T_j = 25\text{ °C}$	1,4	1,9	V
		$T_j = 125\text{ °C}$	1,7	2,2	V
$r_{CE}$	$V_{GE} = 15\text{ V}$	$T_j = 25\text{ °C}$	36		$\text{m}\Omega$
		$T_j = 125\text{ °C}$	43		$\text{m}\Omega$
$V_{CE(sat)}$	$I_{Cnom} = 50\text{ A}, V_{GE} = 15\text{ V}$	$T_j = 25\text{ °C}_{chiplev.}$	3,2	3,7	V
		$T_j = 125\text{ °C}_{chiplev.}$	3,85		V
$C_{ies}$	$V_{CE} = 25, V_{GE} = 0\text{ V} \quad f = 1\text{ MHz}$	3,3			nF
$C_{oes}$		0,5			nF
$C_{res}$		0,22			nF
$t_{d(on)}$	$R_{Gon} = 33\ \Omega$	$V_{CC} = 600\text{ V}$ $I_C = 45\text{ A}$	80		ns
$t_r$			65		ns
$E_{on}$	$R_{Goff} = 33\ \Omega$	$T_j = 125\text{ °C}$ $V_{GE} = \pm 15\text{ V}$	8,36		mJ
$t_{d(off)}$			539		ns
$t_f$			22		ns
$E_{off}$			3,32		mJ
$R_{th(j-s)}$	per IGBT	0,6			K/W

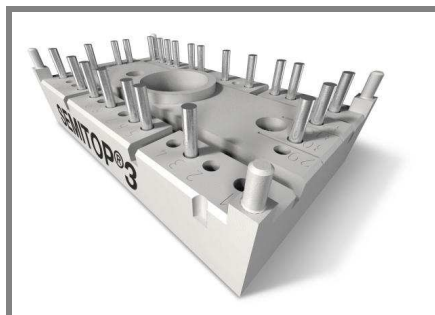

**SEMITOP® 3**

## IGBT Module

**SK60GB125**

Preliminary Data

### Features

- Compact design
- One screw mounting
- Heat transfer and isolation through direct copper bonded aluminium oxide ceramic (DCB)
- High short circuit capability
- Ultra Fast NPT IGBT technology
- $V_{ce,sat}$  with positive coefficient

### Typical Applications\*

- Switching (not for linear use)
- Inverter
- Switched mode power supplies
- UPS

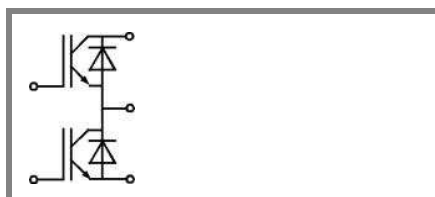

**GB**

### Characteristics

Symbol	Conditions	min.	typ.	max.	Units
<b>Inverse Diode</b>					
$V_F = V_{EC}$	$I_{Fnom} = 50 \text{ A}; V_{GE} = 0 \text{ V}$	$T_j = 25 \text{ }^\circ\text{C}_{chiplev.}$	2		V
		$T_j = 125 \text{ }^\circ\text{C}_{chiplev.}$	1,8		V
$V_{F0}$		$T_j = 25 \text{ }^\circ\text{C}$			V
		$T_j = 125 \text{ }^\circ\text{C}$	1	1,2	V
$r_F$		$T_j = 25 \text{ }^\circ\text{C}$			mΩ
		$T_j = 125 \text{ }^\circ\text{C}$	16	22	mΩ
$I_{RRM}$	$I_F = 50 \text{ A}$		40		A
$Q_{rr}$	$di/dt = -800 \text{ A}/\mu\text{s}$		8		μC
$E_{rr}$	$V_{CC} = 600\text{V}$		2		mJ
$R_{th(j-s)D}$	per diode			0,9	K/W
$M_s$	to heat sink	2,25		2,5	Nm
w			30		g

This is an electrostatic discharge sensitive device (ESDS), international standard IEC 60747-1, Chapter IX.

\* The specifications of our components may not be considered as an assurance of component characteristics. Components have to be tested for the respective application. Adjustments may be necessary. The use of SEMIKRON products in life support appliances and systems is subject to prior specification and written approval by SEMIKRON. We therefore strongly recommend prior consultation of our personal.

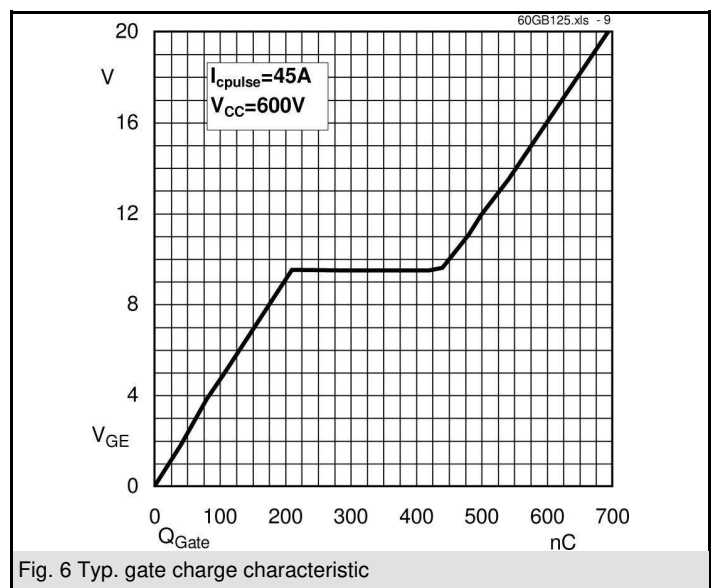
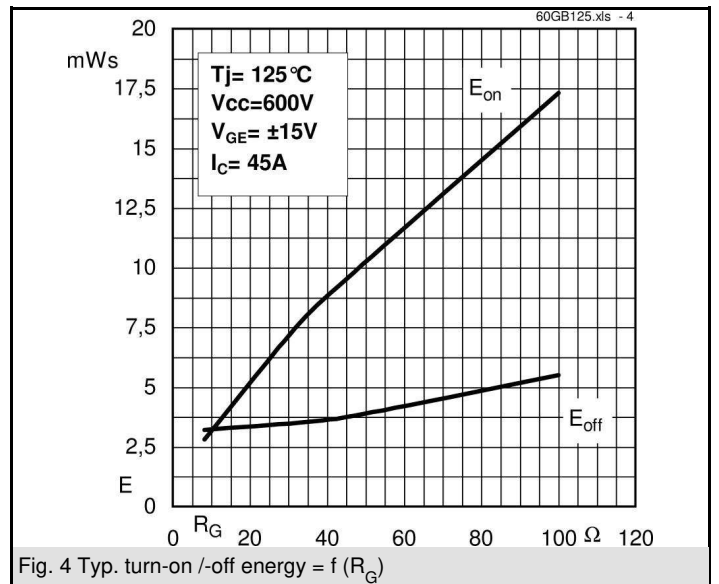
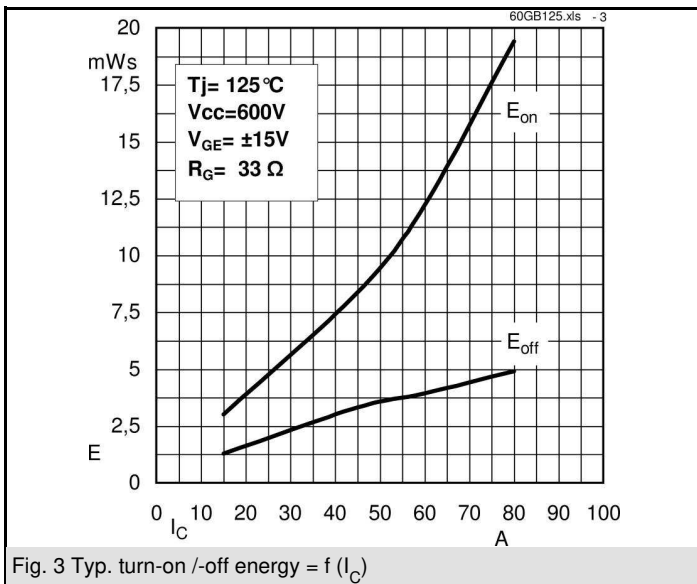
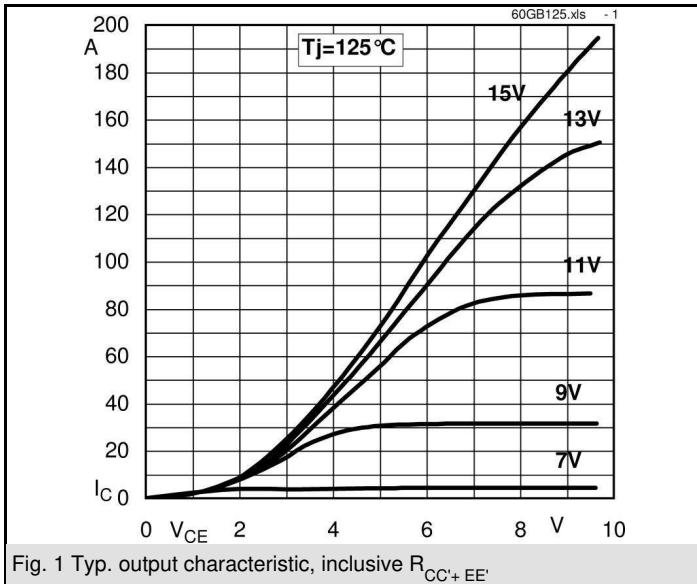

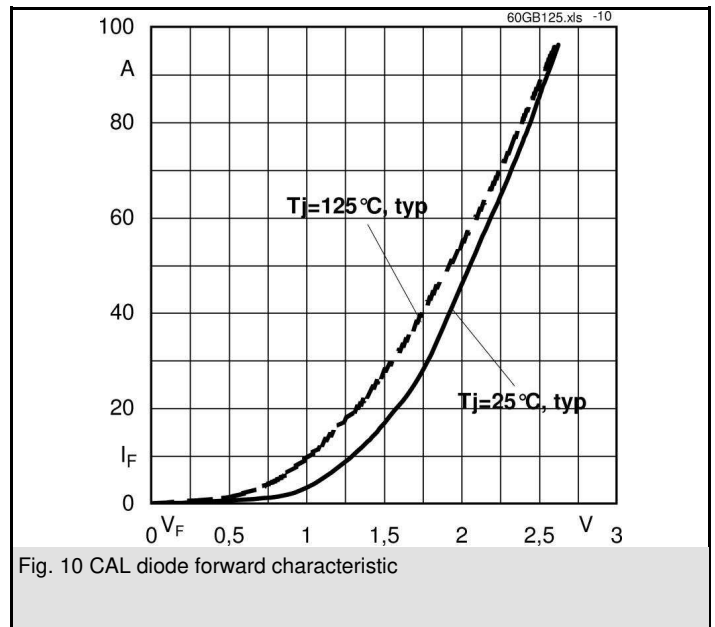
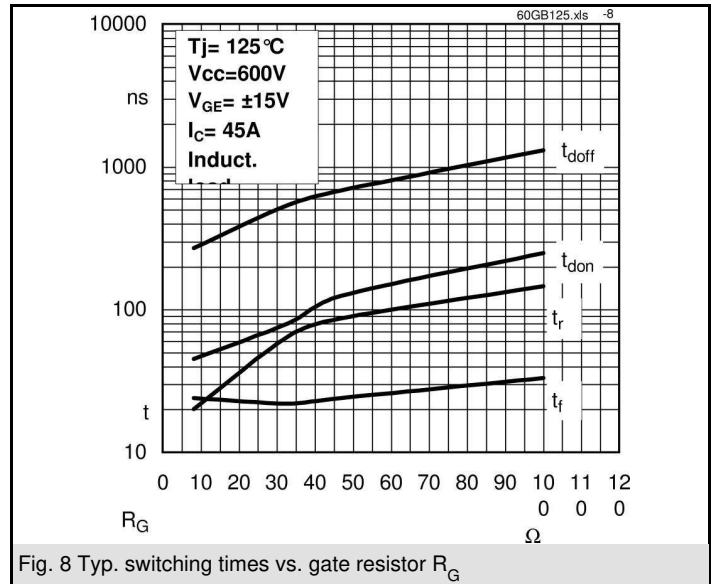
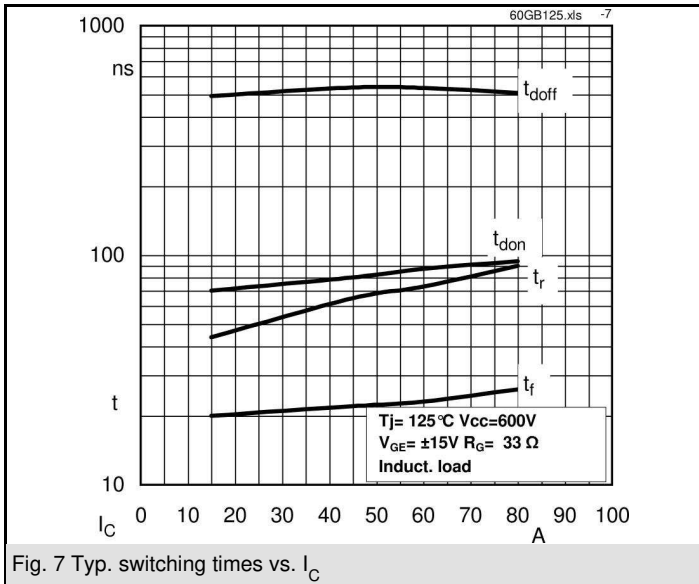

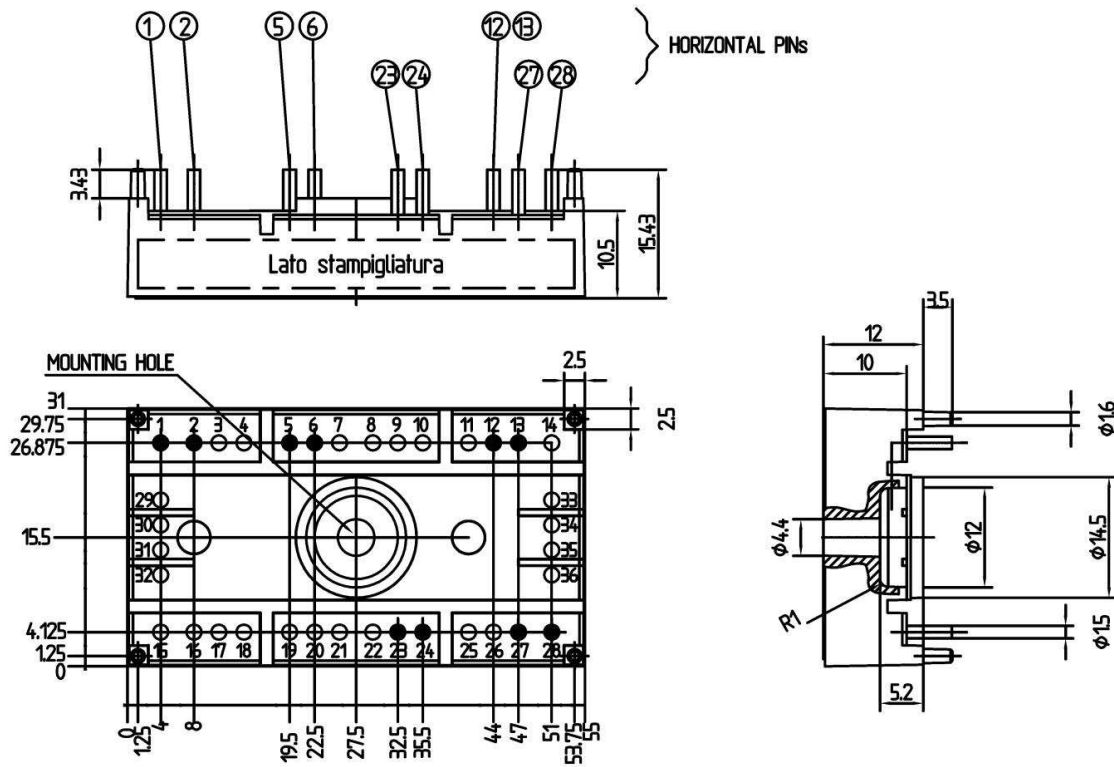

Case T27 (Suggested hole diameter, in the PCB, for solder pins and plastic mounting pins: 2mm)

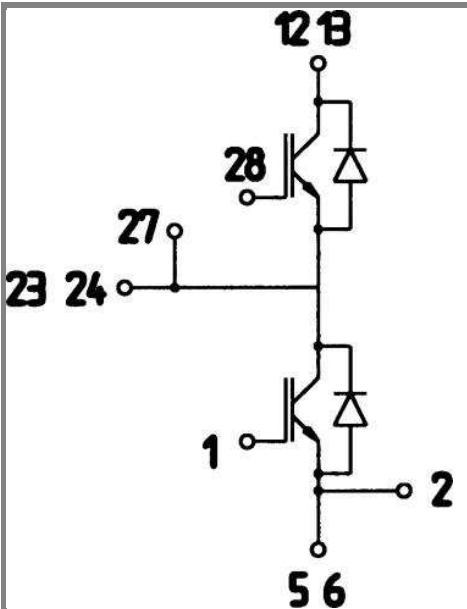

Case T 27

GB