

SKiIP25AC12T4V25

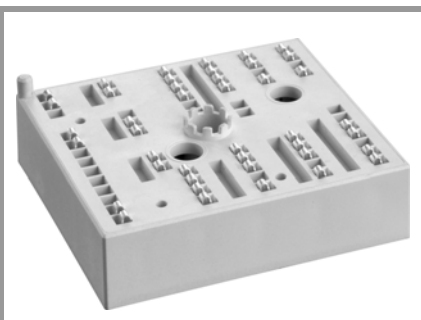

MiniSKiIP® 2

SKiIP25AC12T4V25

Features

- Trench 4 IGBT's
- Robust and soft freewheeling diodes in CAL technology
- Highly reliable spring contacts for electrical connections
- UL recognised file no. E63532

Typical Applications*

- Inverter up to 26 kVA
- Typical motor power 15 kW

Remarks

- V_{CEsat} , V_F = chip level value
- Case temp. limited to $T_C = 125^\circ\text{C}$ max. (for baseplateless modules $T_C = T_S$)
- product rel. results valid for $T_j \leq 150$ (recomm. $T_{op} = -40 \dots +150^\circ\text{C}$)
- Dynamic test results for $V_{cc} = 600\text{V}$, $R_{Gon/off} = 12\Omega$, $I_C = 50\text{A}$, $V_{GE} = \pm 15\text{V}$: $E_{on} = 5.6\text{mJ}$, $E_{off} = 6.1\text{mJ}$, $E_{rr} = 3.3\text{mJ}$, $di/dt_{on} = 1440\text{A}/\mu\text{s}$, $t_{don} = 58\text{ns}$, $t_r = 43\text{ns}$, $di/dt_{off} = 600\text{A}/\mu\text{s}$, $t_{doff} = 370\text{ns}$, $t_f = 65\text{ns}$

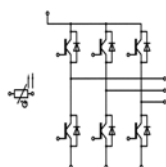

AC

Absolute Maximum Ratings

Symbol	Conditions	Values	Unit	
Inverter - IGBT				
V_{CES}	$T_j = 25^\circ\text{C}$	1200	V	
I_C	$T_j = 175^\circ\text{C}$	$T_s = 25^\circ\text{C}$	69	A
		$T_s = 70^\circ\text{C}$	56	A
I_{Cnom}		50	A	
I_{CRM}	$I_{CRM} = 3 \times I_{Cnom}$	150	A	
V_{GES}		-20 ... 20	V	
t_{psc}	$V_{CC} = 800\text{V}$	10	μs	
	$V_{GE} \leq 15\text{V}$			
	$V_{CES} \leq 1200\text{V}$	$T_j = 150^\circ\text{C}$		
T_j		-40 ... 175	$^\circ\text{C}$	
Inverse - Diode				
I_F	$T_j = 175^\circ\text{C}$	$T_s = 25^\circ\text{C}$	60	A
		$T_s = 70^\circ\text{C}$	48	A
I_{Fnom}		50	A	
I_{FRM}	$I_{FRM} = 3 \times I_{Fnom}$	150	A	
I_{FSM}	10 ms, sin 180°, $T_j = 150^\circ\text{C}$	270	A	
T_j		-40 ... 175	$^\circ\text{C}$	
Module				
$I_{t(RMS)}$	$T_{terminal} = 80^\circ\text{C}$, 20A per spring	60	A	
T_{stg}		-40 ... 125	$^\circ\text{C}$	
V_{isol}	AC sinus 50Hz, t = 1 min	2500	V	

Characteristics

Symbol	Conditions	min.	typ.	max.	Unit
Inverter - IGBT					
$V_{CE(sat)}$	$I_C = 50\text{A}$ $V_{GE} = 15\text{V}$ chipllevel	$T_j = 25^\circ\text{C}$	1.85	2.10	V
		$T_j = 150^\circ\text{C}$	2.20	2.40	V
V_{CE0}		$T_j = 25^\circ\text{C}$	0.8	0.9	V
		$T_j = 150^\circ\text{C}$	0.7	0.8	V
r_{CE}	$V_{GE} = 15\text{V}$	$T_j = 25^\circ\text{C}$	21	24	m Ω
		$T_j = 150^\circ\text{C}$	30	32	m Ω
$V_{GE(th)}$	$V_{GE} = V_{CE}$, $I_C = 1.7\text{mA}$	5	5.8	6.5	V
I_{CES}	$V_{GE} = 0\text{V}$ $V_{CE} = 1200\text{V}$	$T_j = 25^\circ\text{C}$	0.1	0.3	mA
					mA
C_{ies}	$V_{CE} = 25\text{V}$		2.77		nF
C_{oes}	$V_{GE} = 0\text{V}$		0.20		nF
C_{res}			0.16		nF
Q_G	- 8 V...+ 15 V		283		nC
R_{Gint}	$T_j = 25^\circ\text{C}$		4		Ω
$t_{d(on)}$	$V_{CC} = 800\text{V}$	$T_j = 150^\circ\text{C}$	45		ns
t_r	$I_C = 22\text{A}$	$T_j = 150^\circ\text{C}$	19		ns
E_{on}	$R_{Gon} = 12\Omega$	$T_j = 150^\circ\text{C}$	3.4		mJ
$t_{d(off)}$	$R_{Goff} = 1\Omega$ $di/dt_{on} = 1640\text{A}/\mu\text{s}$	$T_j = 150^\circ\text{C}$	480		ns
t_f	$di/dt_{off} = 320\text{A}/\mu\text{s}$	$T_j = 150^\circ\text{C}$	44		ns
E_{off}	$V_{GE} = +15/0\text{V}$	$T_j = 150^\circ\text{C}$	3.1		mJ
$R_{th(j-s)}$	per IGBT		0.71		K/W

SKiIP25AC12T4V25

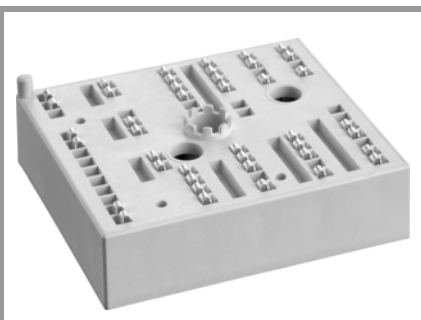

MiniSKiIP® 2

SKiIP25AC12T4V25

Features

- Trench 4 IGBT's
- Robust and soft freewheeling diodes in CAL technology
- Highly reliable spring contacts for electrical connections
- UL recognised file no. E63532

Typical Applications*

- Inverter up to 26 kVA
- Typical motor power 15 kW

Remarks

- V_{CEsat} , V_F = chip level value
- Case temp. limited to $T_C = 125^\circ\text{C}$ max. (for baseplateless modules $T_C = T_S$)
- product rel. results valid for $T_j \leq 150$ (recomm. $T_{op} = -40 \dots +150^\circ\text{C}$)
- Dynamic test results for $V_{cc} = 600\text{V}$, $R_{Gon/off} = 12\Omega$, $I_c = 50\text{A}$, $V_{GE} = \pm 15\text{V}$: $E_{on} = 5.6\text{mJ}$, $E_{off} = 6.1\text{mJ}$, $E_{rr} = 3.3\text{mJ}$, $di/dt_{on} = 1440\text{A}/\mu\text{s}$, $t_{don} = 58\text{ns}$, $t_r = 43\text{ns}$, $di/dt_{off} = 600\text{A}/\mu\text{s}$, $t_{doff} = 370\text{ns}$, $t_f = 65\text{ns}$

Characteristics						
Symbol	Conditions		min.	typ.	max.	Unit
Inverse - Diode						
$V_F = V_{EC}$	$I_F = 50\text{ A}$ $V_{GE} = 0\text{ V}$ chiplevel	$T_j = 25^\circ\text{C}$		2.2	2.5	V
		$T_j = 150^\circ\text{C}$		2.2	2.5	V
V_{F0}		$T_j = 25^\circ\text{C}$		1.3	1.5	V
		$T_j = 150^\circ\text{C}$		0.9	1.1	V
r_F		$T_j = 25^\circ\text{C}$		18	21	m Ω
		$T_j = 150^\circ\text{C}$		26	28	m Ω
I_{RRM}	$I_F = 22\text{ A}$	$T_j = 150^\circ\text{C}$		0		A
Q_{rr}	$di/dt_{off} = 1680\text{ A}/\mu\text{s}$	$T_j = 150^\circ\text{C}$		5.5		μC
E_{rr}	$V_{GE} = 0\text{ V}$ $V_{CC} = 800\text{ V}$	$T_j = 150^\circ\text{C}$		2.9		mJ
$R_{th(j-s)}$	per Diode			0.95		K/W
Module						
M_s	to heat sink		2		2.5	Nm
w				65		g
Temperatur Sensor						
R_{100}	$T_C = 100^\circ\text{C}$ ($R_{25} = 1000\Omega$)			1670 \pm 3%		Ω
$R(T)$	$R(T) = 1000\Omega [1 + A(T - 25^\circ\text{C}) + B(T - 25^\circ\text{C})^2]$], $A = 7.635 \cdot 10^{-3} \text{ }^\circ\text{C}^{-1}$, $B = 1.731 \cdot 10^{-5} \text{ }^\circ\text{C}^{-2}$					

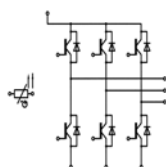

AC

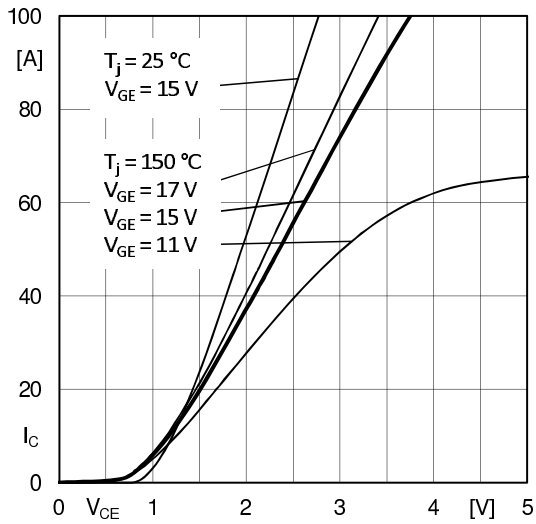

Fig. 1: Typ. output characteristic, inclusive $R_{CC'+EE'}$

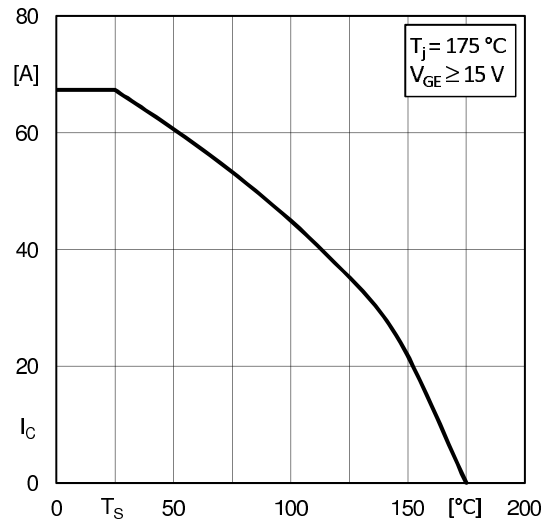

Fig. 2: Rated current vs. temperature $I_C = f(T_S)$

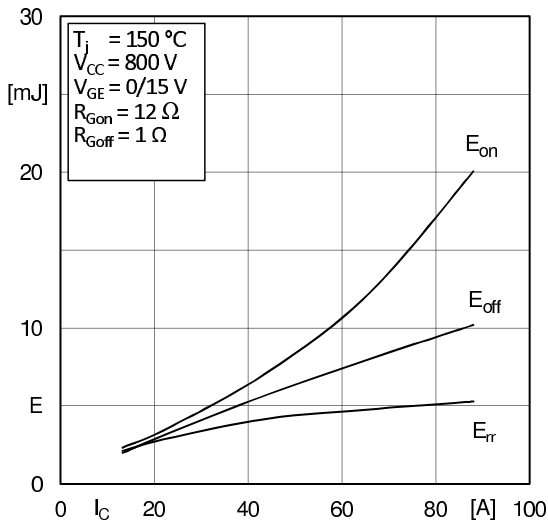

Fig. 3: Typ. turn-on /-off energy = $f(I_C)$

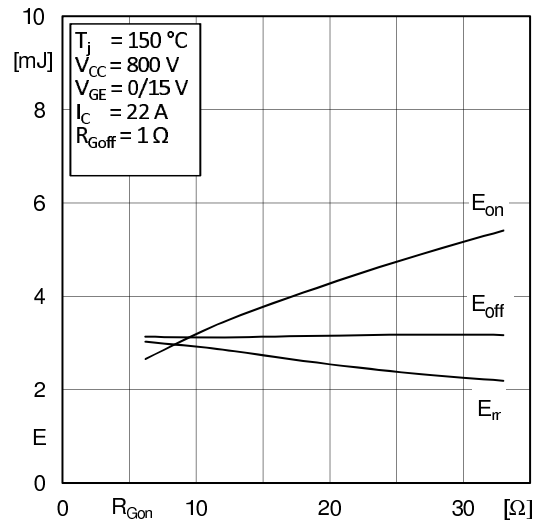

Fig. 4: Typ. turn-on /-off energy = $f(R_G)$

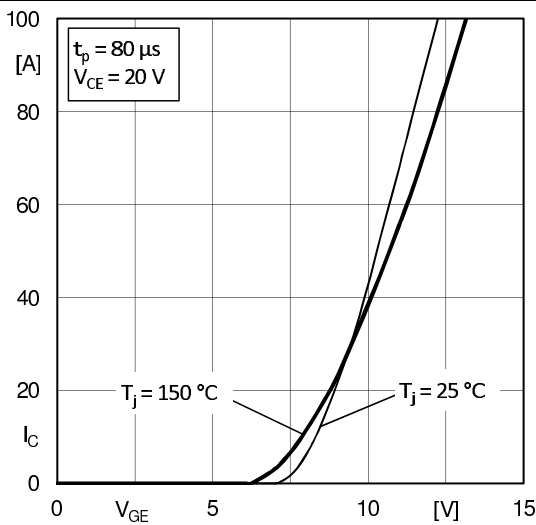

Fig. 5: Typ. transfer characteristic

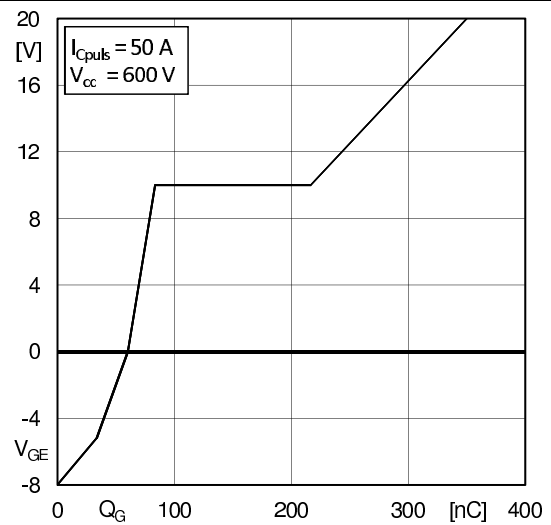

Fig. 6: Typ. gate charge characteristic

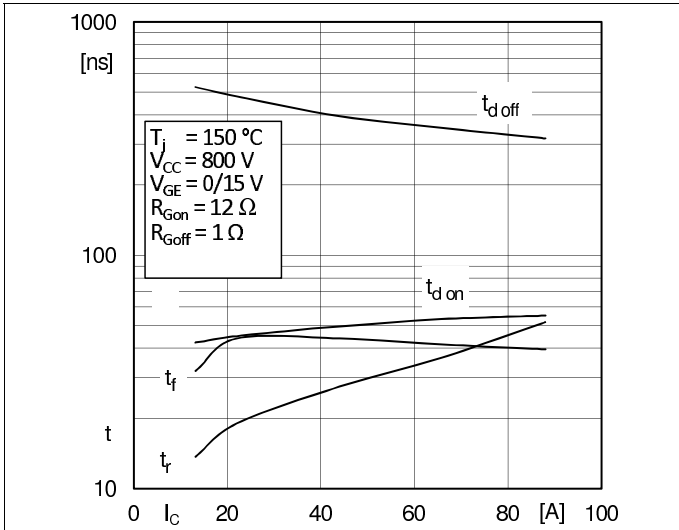

Fig. 7: Typ. switching times vs. I_C

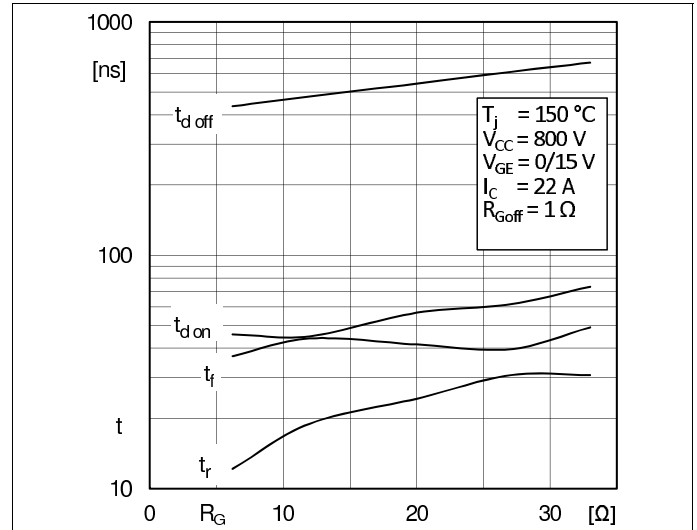

Fig. 8: Typ. switching times vs. gate resistor R_G

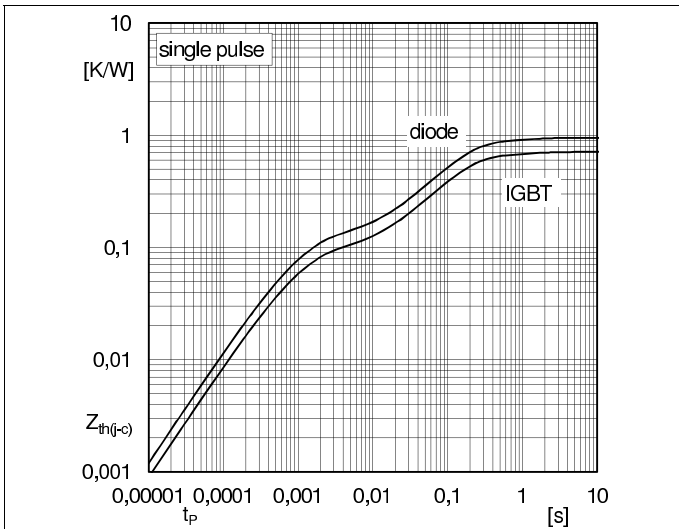

Fig. 9: Transient thermal impedance of IGBT and Diode

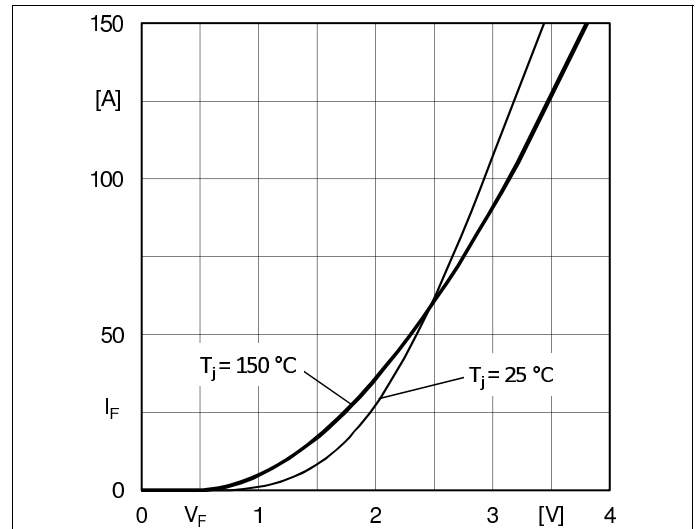

Fig. 10: CAL diode forward characteristic

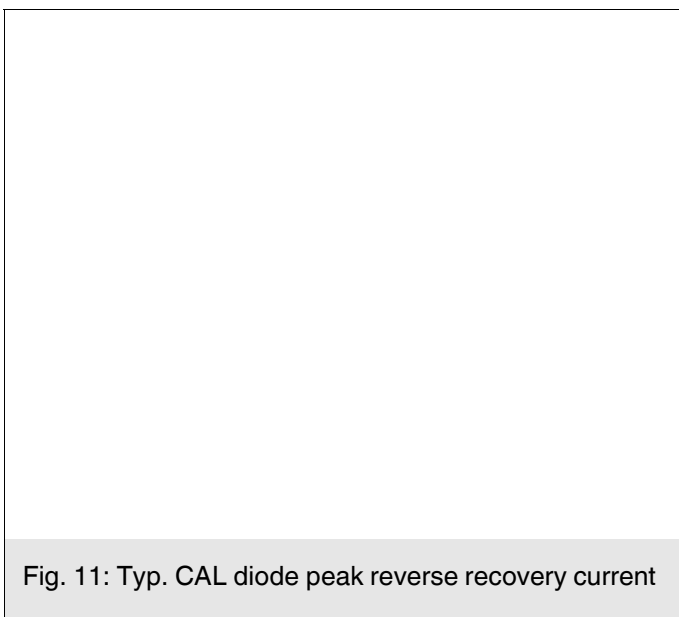

Fig. 11: Typ. CAL diode peak reverse recovery current

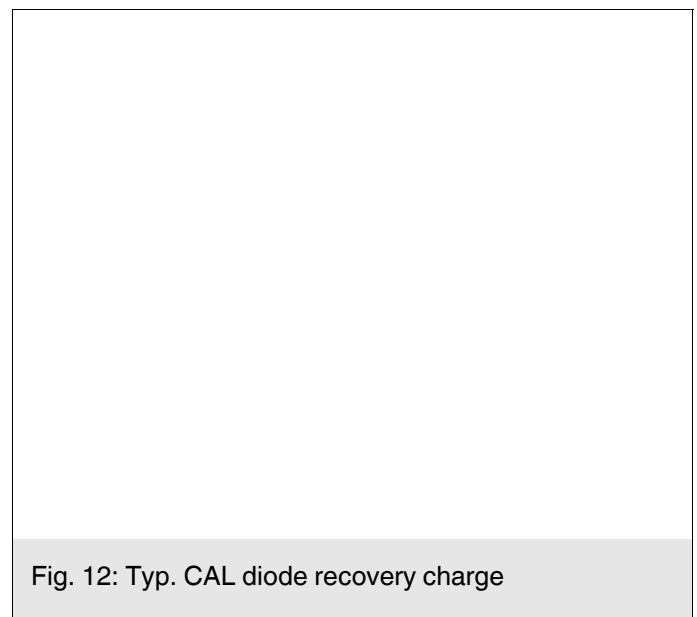
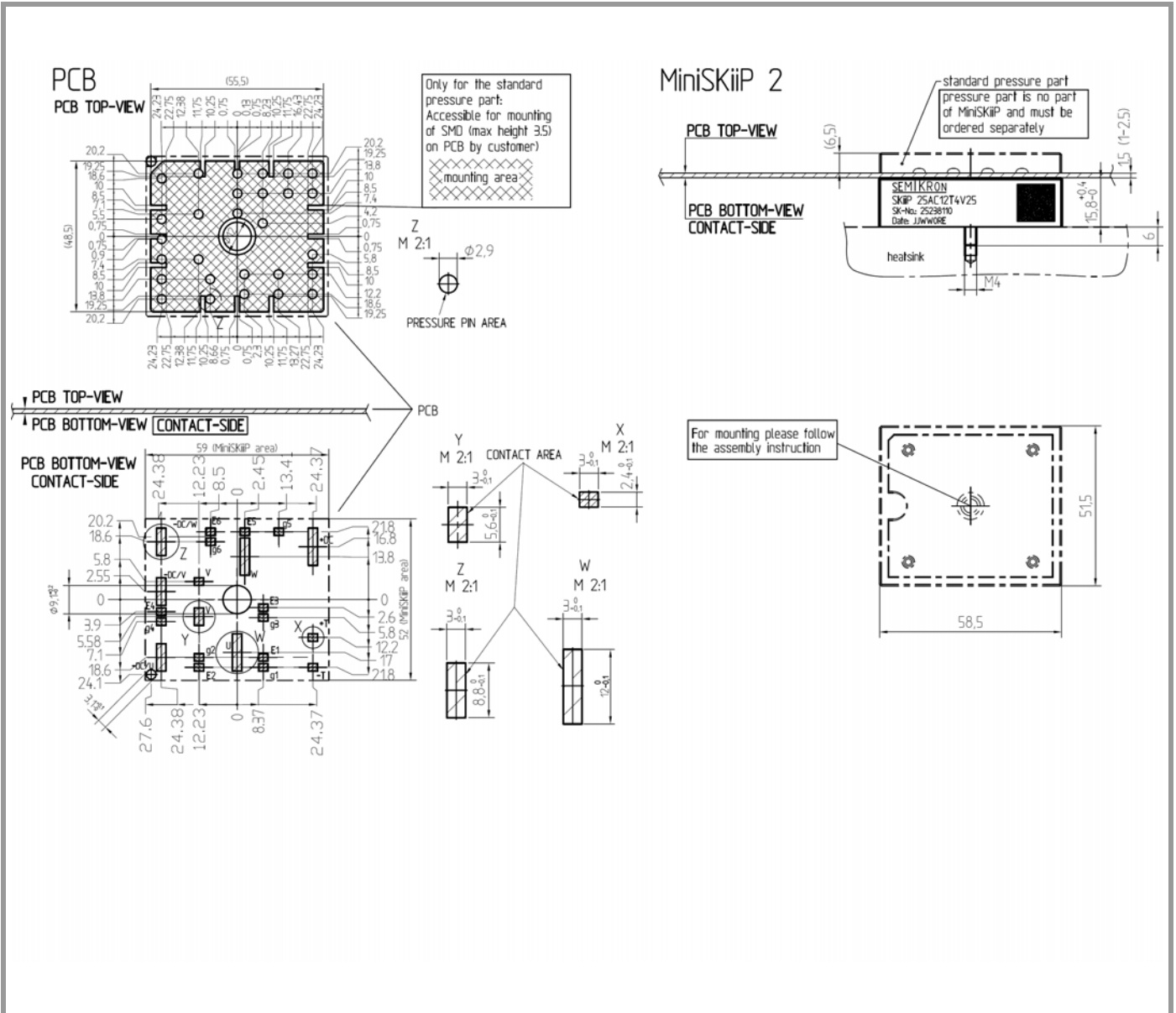
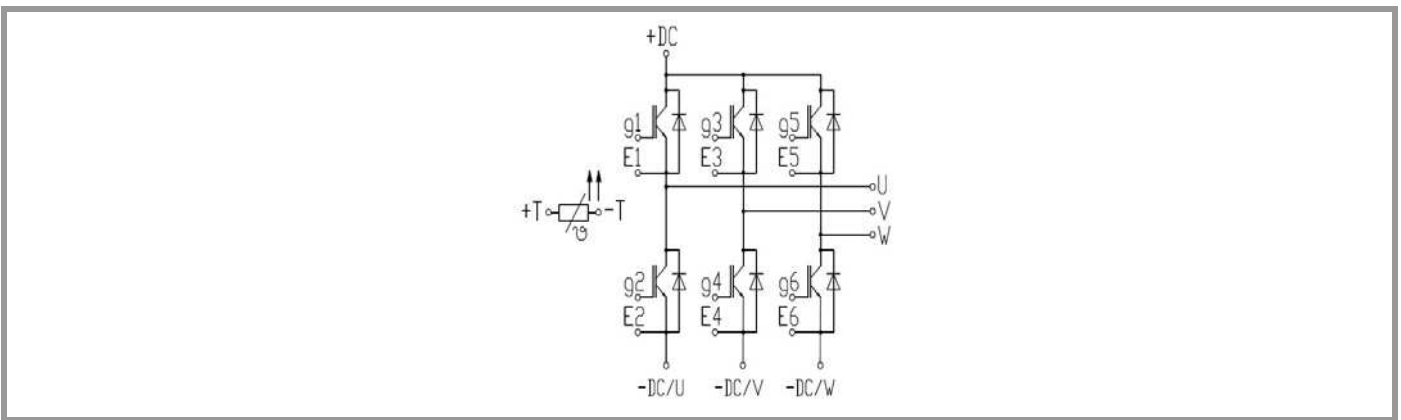

Fig. 12: Typ. CAL diode recovery charge



pinout, dimensions



pinout

This is an electrostatic discharge sensitive device (ESDS), international standard IEC 60747-1, Chapter IX

* The specifications of our components may not be considered as an assurance of component characteristics. Components have to be tested for the respective application. Adjustments may be necessary. The use of SEMIKRON products in life support appliances and systems is subject to prior specification and written approval by SEMIKRON. We therefore strongly recommend prior consultation of our staff.